



106



EKARTÖRLER
RETRACTORS



MS 106-101
16,0 cm / 6¹/₄"



MS 106-102
16,0 cm / 6¹/₄"



MS 106-103
16,0 cm / 6¹/₄"



MS 106-104
16,0 cm / 6¹/₄"



sivri
sharp

MS 106-110
15,0cm / 6"



künt
blunt

MS 106-111
15,0cm / 6"

GRAEFE



MS 106-120
15,5 cm / 6¹/₄"



MS 106-121
15,5 cm / 6¹/₄"

GUTHRIE



O'CONNOR

MS 106-122 16,0 cm / 6¹/₄"



MS 106-130



MS 106-131



MS 106-132



MS 106-133

sivri
sharp
16,0 cm / 6 1/4"



MS 106-140



MS 106-141

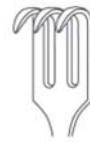

MS 106-142



MS 106-143

yarı sivri
semi-sharp
16,0 cm / 6 1/4"

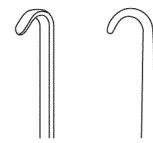

MS 106-150

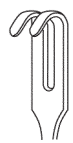

MS 106-151



MS 106-152



MS 106-153

künt
blunt
16,0 cm / 6 1/4"

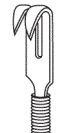

MS 106-160



MS 106-161



MS 106-162

sivri
sharp
16,0 cm / 6 1/4"

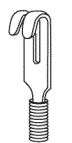

MS 106-170



MS 106-171



MS 106-172

künt
blunt
16,0 cm / 6 1/4"

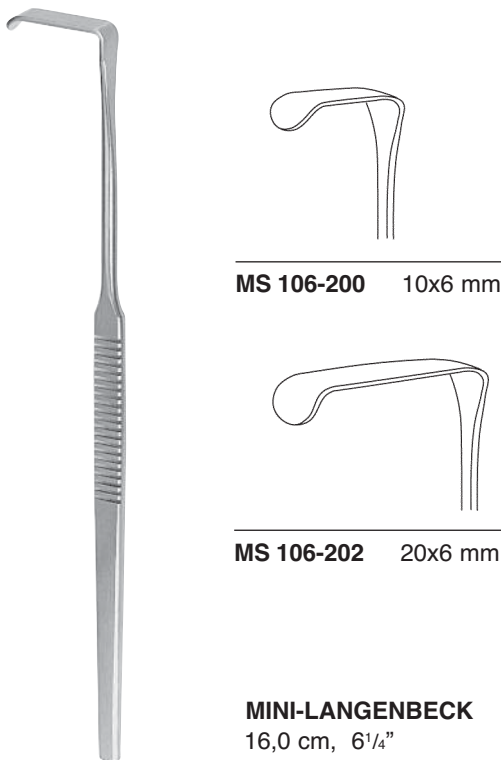
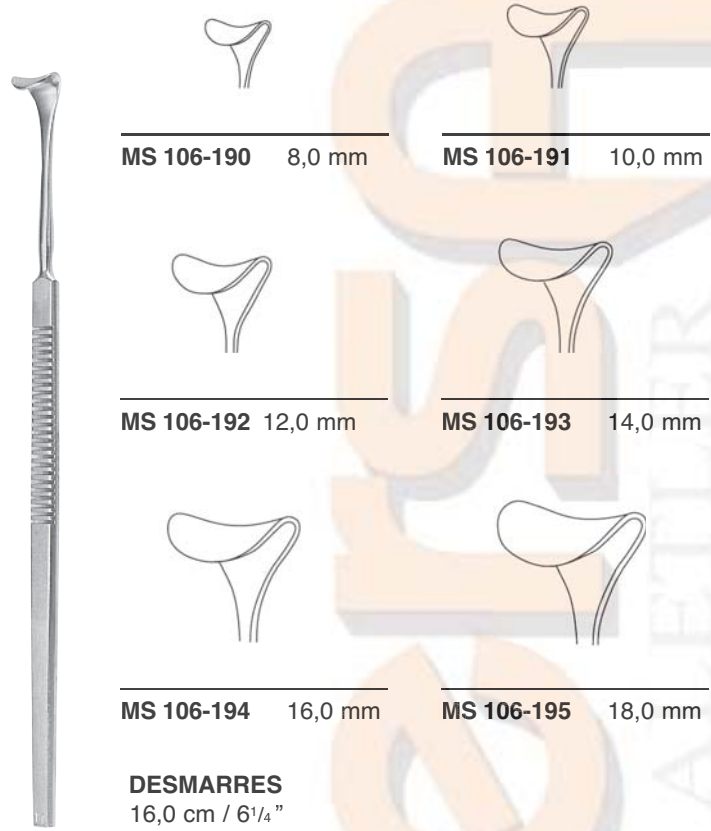
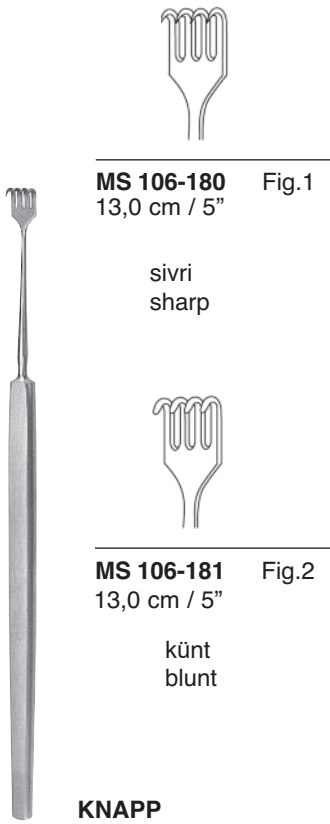



MS 106-210 14x8 mm
16,0 cm, 6¹/₄"



MS 106-211 18x7 mm



MS 106-212 16x5 mm



MS 106-213 7x4 mm



MS 106-214 10x3 mm



MS 106-215 7x4 mm



MS 106-216 10x4 mm



MEYERDING
16,0 cm / 6¹/₄"



16,5 cm, 6¹/₂"



MS 106-230



MS 106-231



MS 106-232



MS 106-233



MS 106-240



MS 106-241



MS 106-242



MS 106-243



MS 106-250 16x6 mm

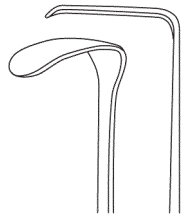

MS 106-251 24x6 mm

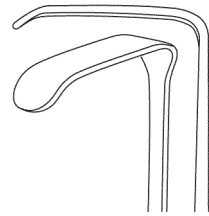

LANGENBECK-GREEN
16,0 cm, 6¹/₄"



MS 106-260 10x6 mm



MS 106-261 20x6 mm



16,0 cm, 6¹/₄"



RAGNELL-DAVIS

MS 106-270 14,0 cm / 5¹/₂"



RAGNELL

MS 106-271 15,0 cm / 6"

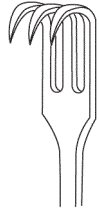

MS 106-280

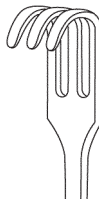

MS 106-281

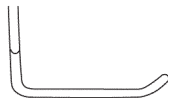

SENN-MILLER
16,0 cm / 6 1/4"

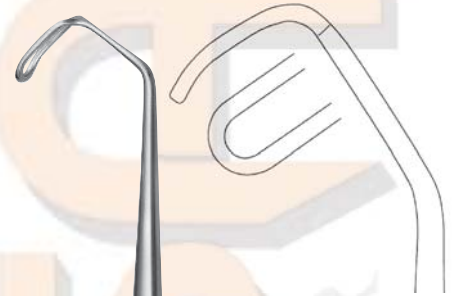

CUSHING

MS 106-290 20,0 cm / 8"



MS 106-291 8 mm



MS 106-292 10 mm



MS 106-293 12 mm



MS 106-294 14 mm

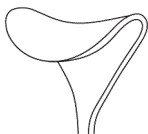

MS 106-295 16 mm

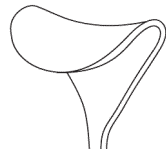

MS 106-296 18 mm

CUSHING
20,0 cm / 8"



MS 106-297 8 mm



MS 106-298 10 mm



MS 106-299 12 mm



MS 106-300 14 mm



MS 106-301 16 mm



MS 106-302 18 mm

CUSHING
24,0 cm / 9 1/2"

flexible



MS 106-320 8 mm



MS 106-321 11 mm



MS 106-322 13 mm



MS 106-323 17 mm



MS 106-324 20 mm



MS 106-325 23 mm

GIL-VERNET
24,0 cm / 9½"

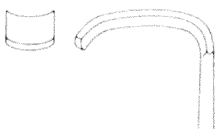

MS 106-340
Fig. 1

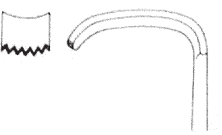

MS 106-341
Fig. 2

STRANDELL-STILLE
19,0 cm / 7½"



CUSHING

MS 106-350 21,5 cm / 8½"



VOLKMANN
21,5 cm / 8½"



MS 106-360



MS 106-361



MS 106-362



MS 106-363

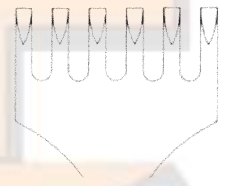

MS 106-364

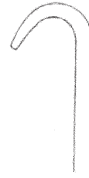

MS 106-370



MS 106-371



MS 106-372



MS 106-373

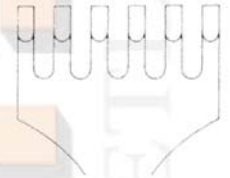

MS 106-374



VOLKMANN
22,0 cm / 8½"



MS 106-380



MS 106-381 9x8 mm



MS 106-383 9x19 mm



MS 106-384 9x29 mm



MS 106-382 9x13 mm



VOLKMANN
22,0 cm / 8³/₄"

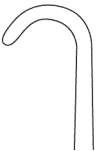

MS 106-400



MS 106-403 9x19 mm



MS 106-401 9x8 mm



MS 106-404 9x29 mm



MS 106-402 9x13 mm



MS 106-410



MS 106-413 9x19 mm

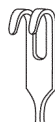

MS 106-411 9x8 mm



MS 106-414 9x29 mm



MS 106-412 9x13 mm



VOLKMANN
22,0 cm / 8³/₄"



VOLKMANN
21,5 cm / 8¹/₂"

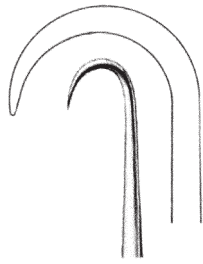

MS 106-420



MS 106-421

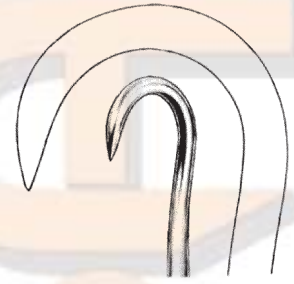

MS 106-422



KOCHER
22 0 cm / 8⁵/₈"

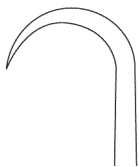

MS 106-430

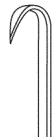

MS 106-431 9x8 mm



MS 106-432 15x15 mm



MS 106-433 15x20 mm



MS 106-434 15x30 mm



MS 106-435 15x40 mm



KOCHER
22,0 cm / 8⁵/₈"



MS 106-440



MS 106-443 15x20 mm



MS 106-441 9x8 mm



MS 106-444 15x30 mm



MS 106-442 15x15 mm

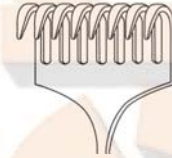

MS 106-445 15x40 mm



KOCHER
22,0 cm / 8⁵/₈"

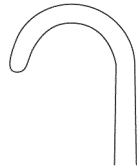

MS 106-450



MS 106-453 15x20 mm



MS 106-451 9x8 mm



MS 106-454 15x30 mm



MS 106-452 15x15 mm



MS 106-455 15x40 mm



OLLIER

MS 106-461 23,0 cm / 9" 36x30 mm



WASSMUND

MS 106-470 20,5 cm / 8" 33x21 mm

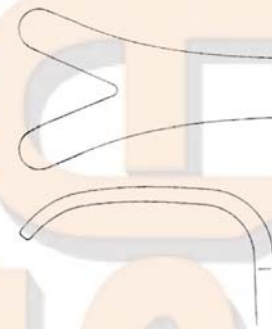

OLLIER

MS 106-460 23,0 cm / 9" 36x60 mm

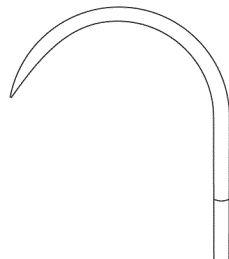

WASSMUND

MS 106-470 20,5 cm / 8" 33x21 mm



künt
blunt

KOERTE

MS 106-480 24,0 cm / 9 1/2"

KOERTE

MS 106-481 24,0 cm / 9 1/2"



künt
blunt

ISRAEL
25,0 cm / 9³/₄"



MS 106-490 40x40 mm



MS 106-491 45x50 mm



MS 106-492 50x60 mm



MS 106-493 70x70 mm

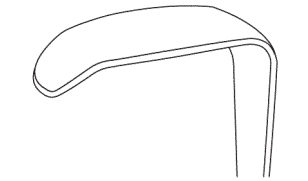

MS 106-500 30x11 mm

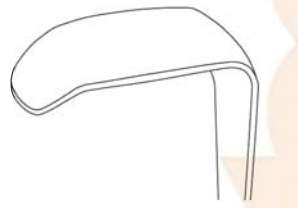

MS 106-501 30x14 mm

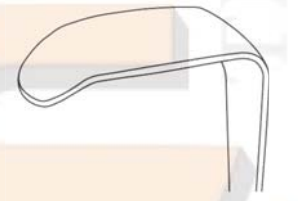

MS 106-502 30x16 mm

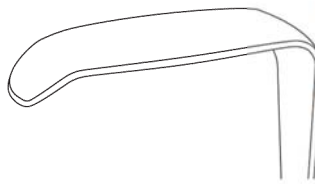

MS 106-503 40x11 mm



MS 106-504 50x11 mm

LANGENBECK
22,5 cm / 9"



LANGENBECK
22,0 cm / 8⁵/₈"

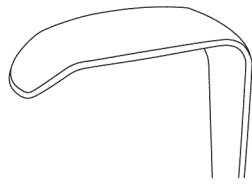

MS 106-510 30x11 mm

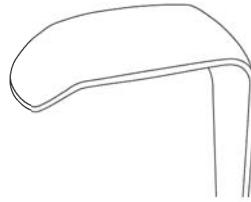

MS 106-511 30x14 mm

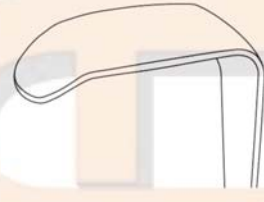

MS 106-512 30x16 mm

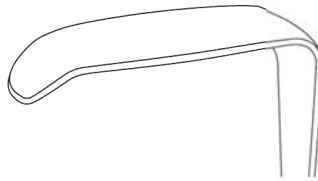

MS 106-513 40x11 mm



MS 106-514 50x11 mm

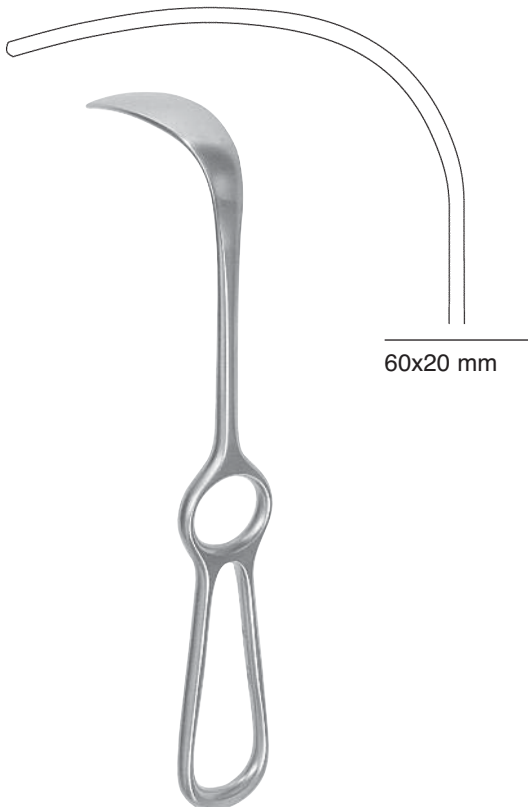

LANGENBECK
MS 106-520 21,0 cm / 8¹/₄"

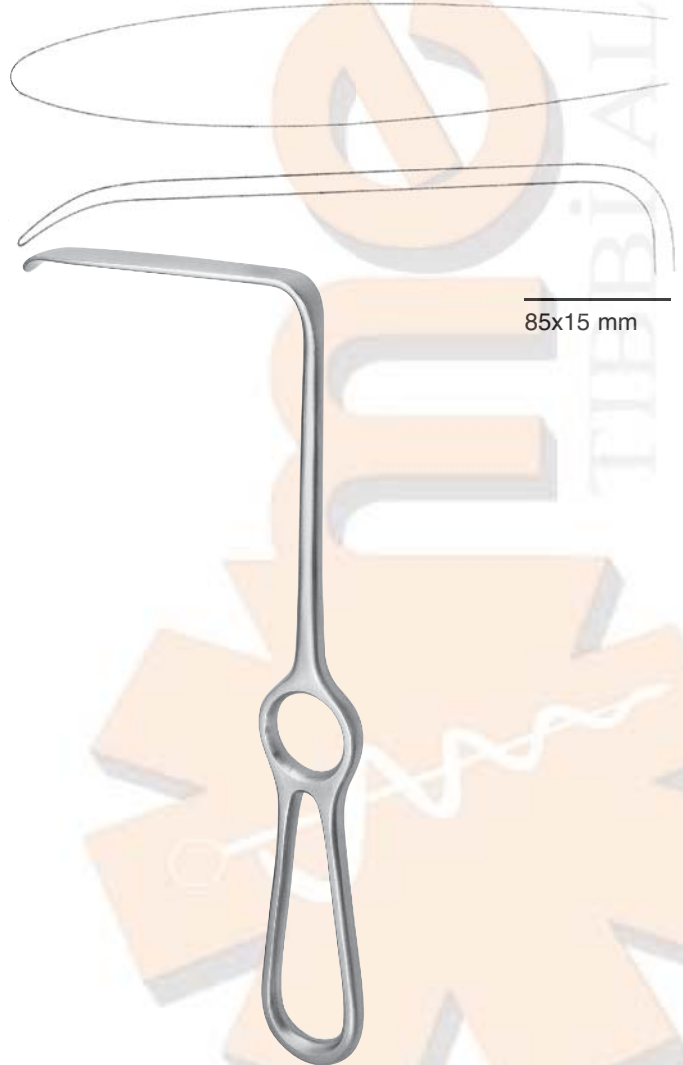

LANGENBECK
MS 106-521 22,5 cm / 9"



LAHEY
MS 106-522 19,0 cm / 7½"



LITTLE
MS 106-523 20,0 cm / 8"



KOCHER-LANGENBECK
21,5 cm / 8½"

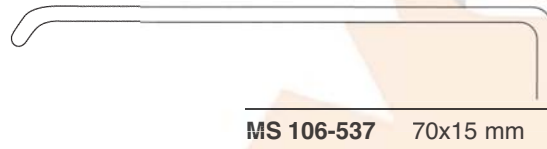
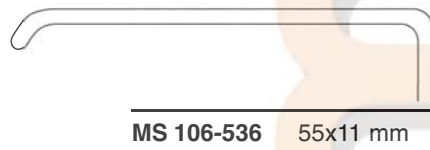
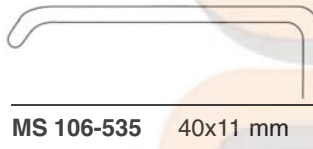
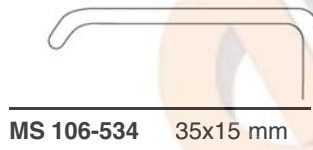
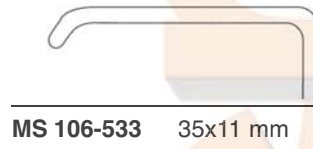
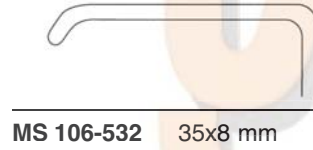
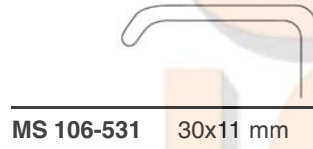
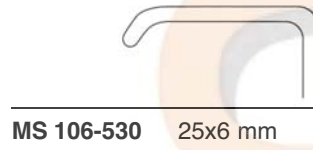



KOCHER
23,0 cm / 9"



SAUERBRUCH
22,5 cm / 8³/₄"

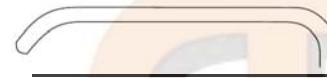

MS 106-550 40x18 mm



MS 106-551 60x20 mm



MS 106-552 60x25 mm



MS 106-553 75x30 mm



MS 106-554 75x40 mm



MS 106-560 50x15 mm



MS 106-561 63x23 mm



MS 106-562 80x20 mm



ZENKER

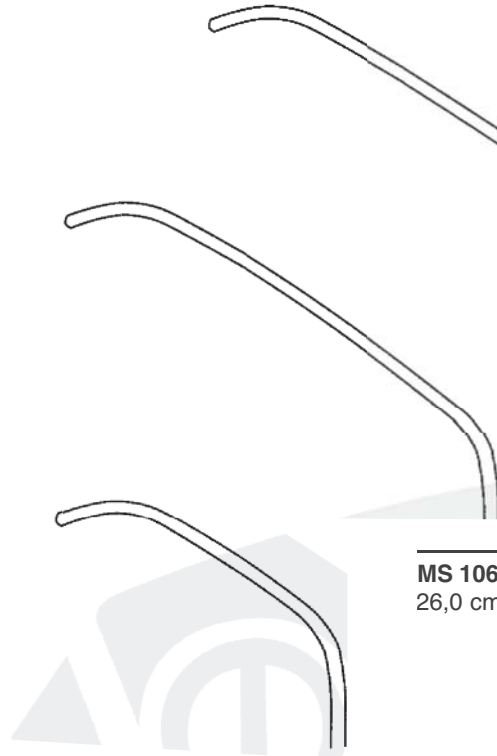

MS 106-572
27,5 cm / 10³/₄"

MS 106-571
26,0 cm / 10"

MS 106-570
25,0 cm / 9³/₄"



KOCHER

MS 106-580	19,0 cm / 7 ¹ / ₂ "	19 x 12 mm
MS 106-581	19,0 cm / 7 ¹ / ₂ "	21 x 14 mm

KOCHER

MS 106-582	42x10 mm
MS 106-583	42x15 mm
MS 106-584	43x20 mm



MS 106-600 18x17 mm
21,5 cm / 8¹/₂"

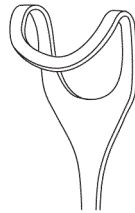

MS 106-601 25x22 mm
23,0 cm / 9"

MIDDELDORPF



MS 106-603 14x17 mm
21,5 cm / 8¹/₂"



MS 106-604 20x22 mm
22 cm / 8⁵/₈"

MIDDELDORPF



MS 106-602 31x30 mm
24,5 cm / 9²/₃"



MS 106-605 26x30 mm
23,5 cm / 9¹/₂"



RICHARDSON-EASTMAN

- MS 106-610** Fig. 1+2 27,0 cm / 10³/₄"
- MS 106-611** Fig. 1 26,0 cm / 10¹/₄"
- MS 106-612** Fig. 2 27,0 cm / 10³/₄"



RICHARDSON

24,0 cm / 9¹/₂"

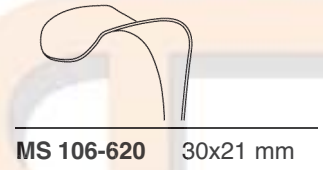

MS 106-620 30x21 mm

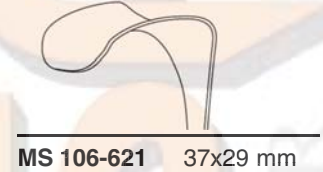

MS 106-621 37x29 mm

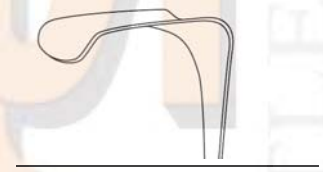

MS 106-622 45x40 mm

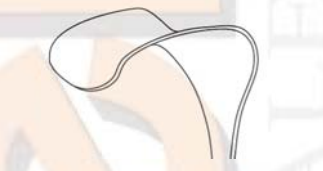

MS 106-623 53x22 mm



KELLY

MS 106-630 26,0 cm / 10¹/₄" 70 x 50 mm

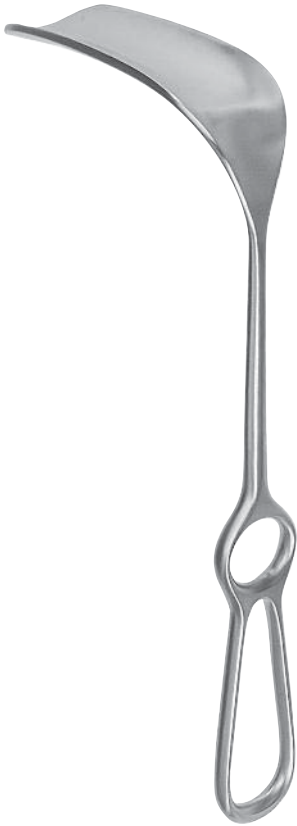

DOYEN-STILLE
26,0 cm / 10¹/₄"



MS 106-640 127x52 mm



MS 106-641 101x31 mm

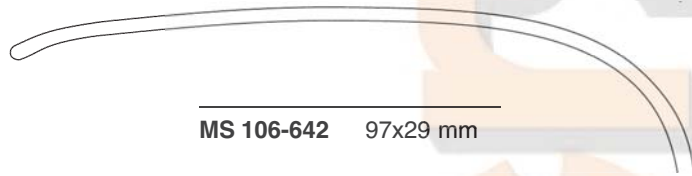

MS 106-642 97x29 mm



HÖSEL
26,0 cm / 10¹/₄"

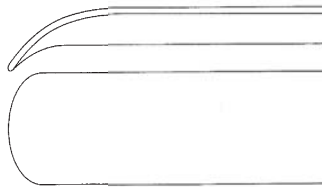

MS 106-650 63x21 mm



MS 106-651 83x30 mm
MS 106-652 103x30 mm
MS 106-653 120x30 mm
MS 106-654 140x30 mm

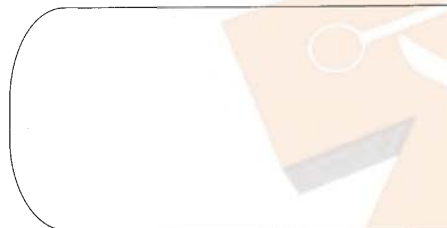

MS 106-655 140x40 mm

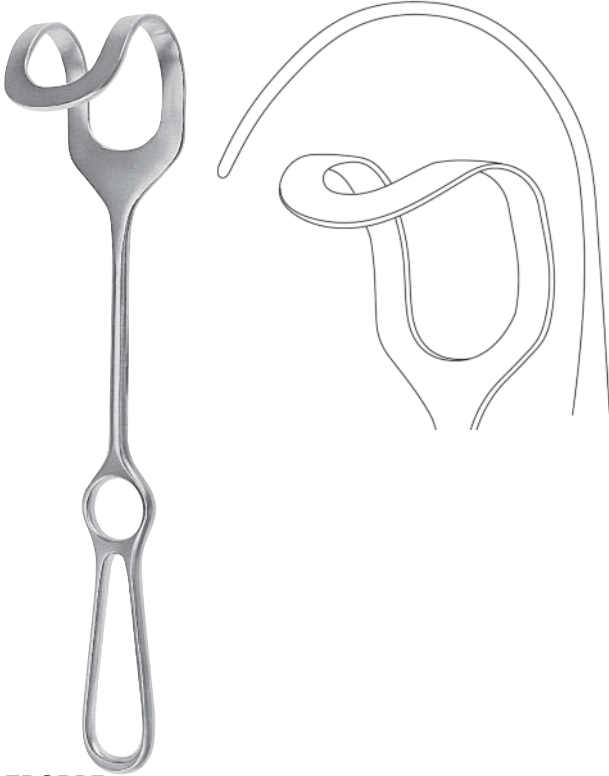

MIDDLEORPF

MS 106-670	27,0 cm / 10 ³ / ₄ "	48x45 mm
MS 106-671	27,0 cm / 10 ³ / ₄ "	52x50 mm
MS 106-672	28,0 cm / 11"	60x70 mm



FRITSCH

MS 106-680	23,5 cm / 9 ¹ / ₄ "	30x30 mm
MS 106-681	24,0 cm / 9 ¹ / ₂ "	32x40 mm
MS 106-682	25,0 cm / 9 ³ / ₄ "	40x50 mm
MS 106-683	25,0 cm / 9 ³ / ₄ "	40x60 mm
MS 106-684	25,5 cm / 10"	45x75 mm
MS 106-685	26,5 cm / 10 ¹ / ₂ "	65x85 mm



DOYEN

MS 106-700	25,0 cm / 10"
-------------------	---------------

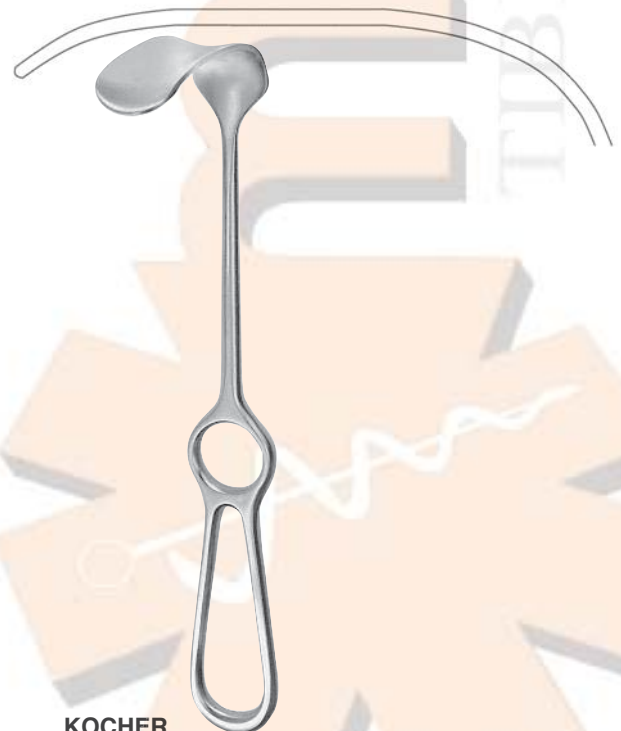

KOCHER

MS 106-710	25,0 cm / 10"	70x25 mm
MS 106-711	25,0 cm / 10"	80x45 mm
MS 106-712	25,0 cm / 10"	80x55 mm
MS 106-713	25,0 cm / 10"	80x65 mm

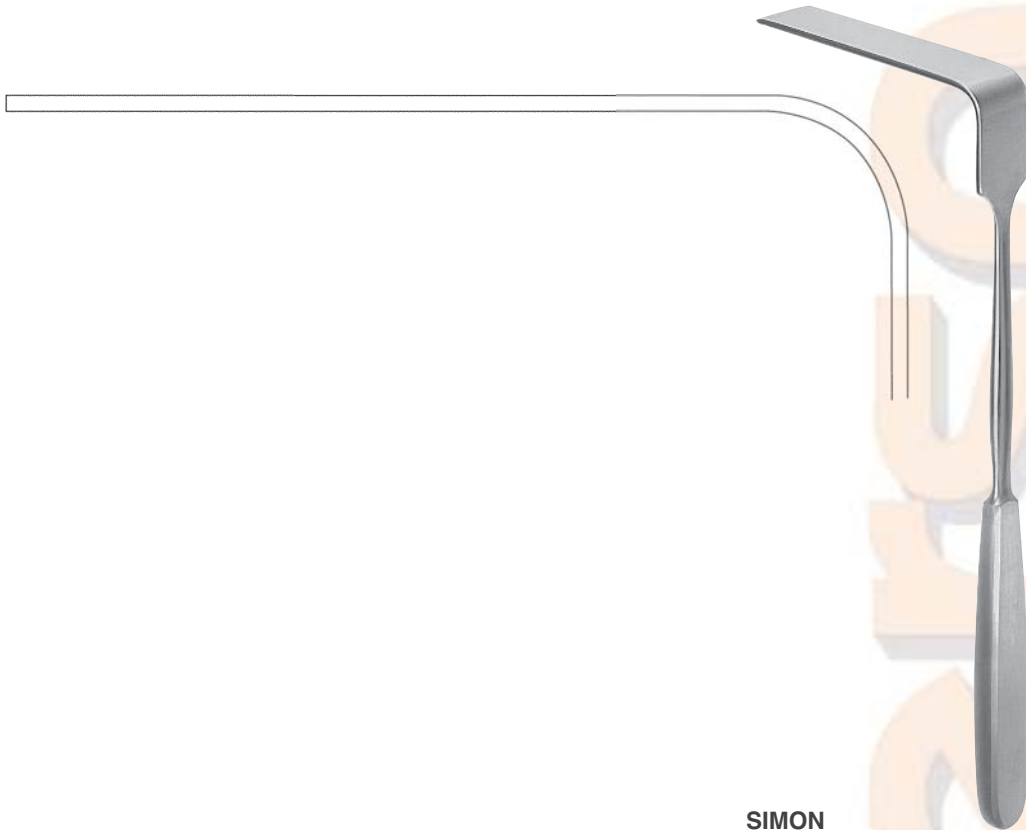

SIMON

MS 106-720	28,0 cm / 11"	115x22 mm
MS 106-721	28,0 cm / 11"	115x27 mm

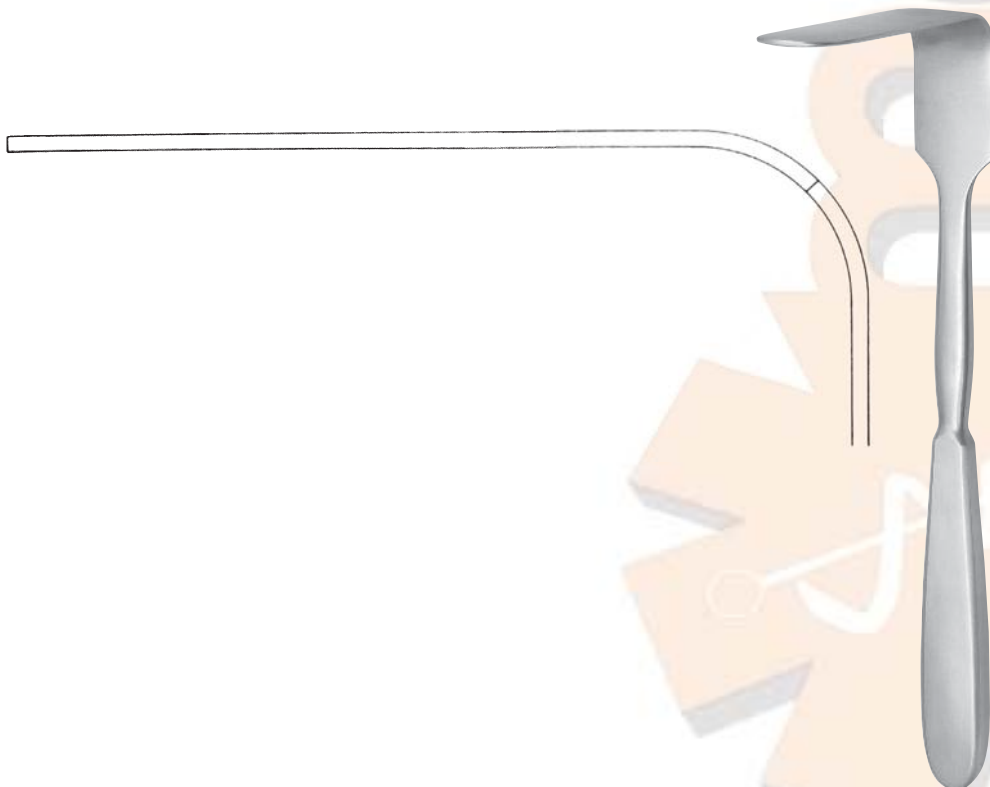

MARTIN

MS 106-722	26,0 cm / 10"	110 x 27 mm
-------------------	---------------	-------------

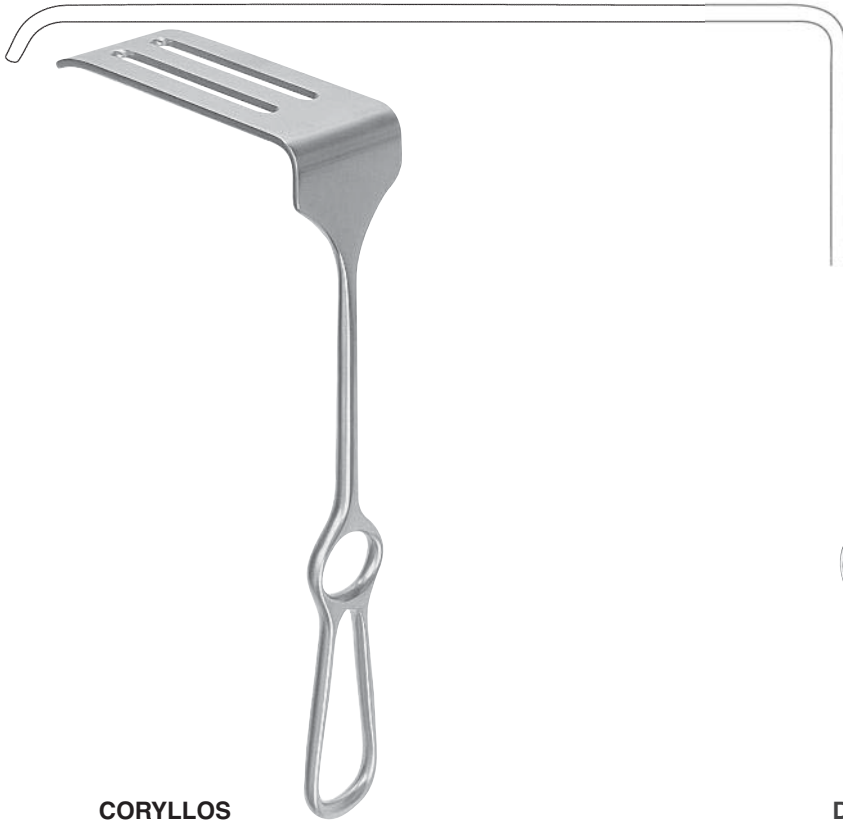

CORYLLOS

MS 106-730	24,0 cm / 9 1/2"	85x22 mm
MS 106-731	24,0 cm / 9 3/4"	108x43 mm
MS 106-732	24,0 cm / 9 3/4"	119x65 mm



DAVIDSON

MS 106-740	19,0 cm / 6 1/4"	80x54 mm
MS 106-741	18,5 cm / 6 1/4"	80x95 mm



SAUERBRUCH

MS 106-742	25,5 cm / 10"	127x38 mm
-------------------	---------------	-----------



MS 106-755 182x30 mm



MS 106-754 162x30 mm



MS 106-753 140x25 mm



MS 106-752 122x25 mm



MS 106-751 102x20 mm

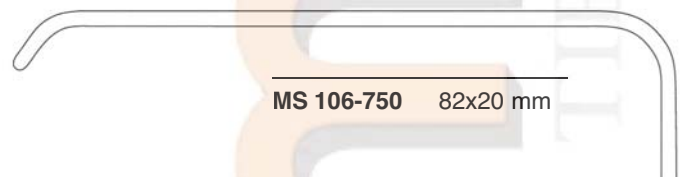

MS 106-750 82x20 mm



BRUNNER
25,0 cm / 9³/₄"

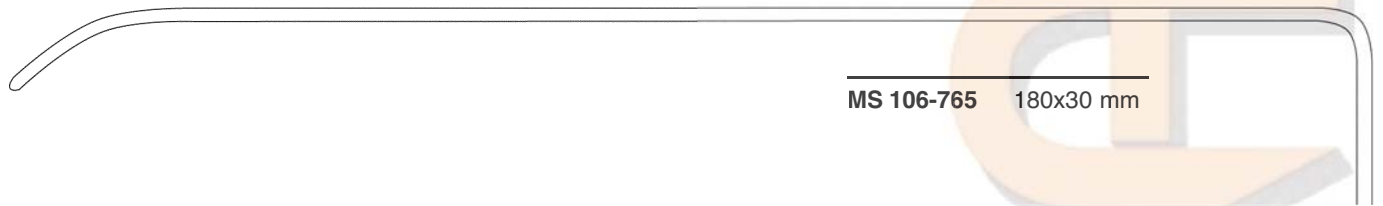

MS 106-765 180x30 mm

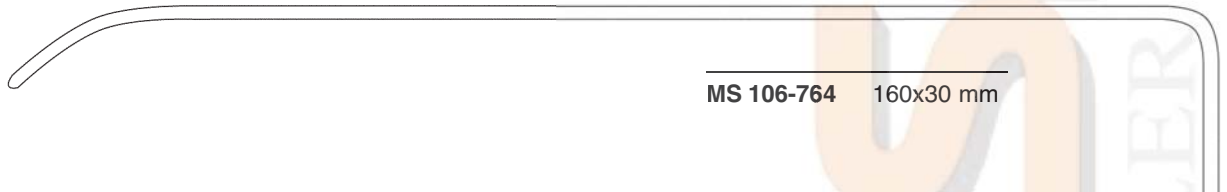

MS 106-764 160x30 mm

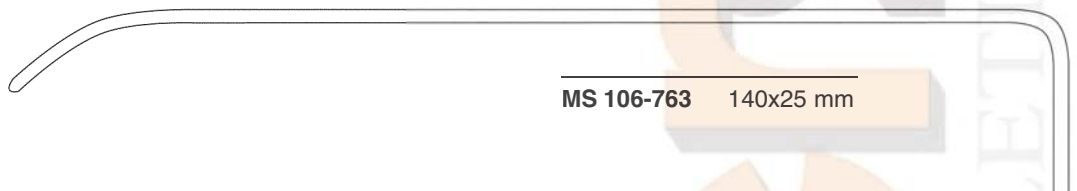

MS 106-763 140x25 mm

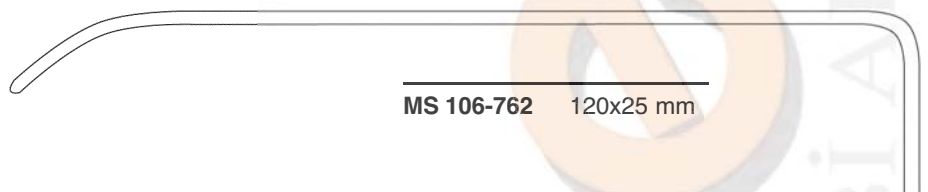

MS 106-762 120x25 mm



BRUNNER
25,0 cm / 9³/₄"



MS 106-761 100x20 mm

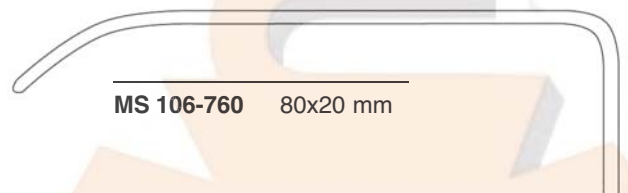

MS 106-760 80x20 mm

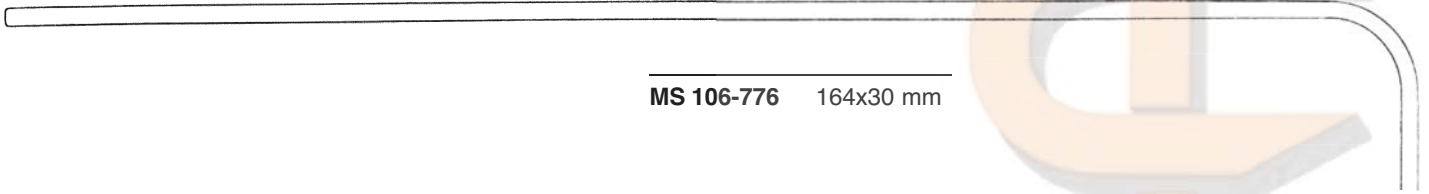

MS 106-776 164x30 mm

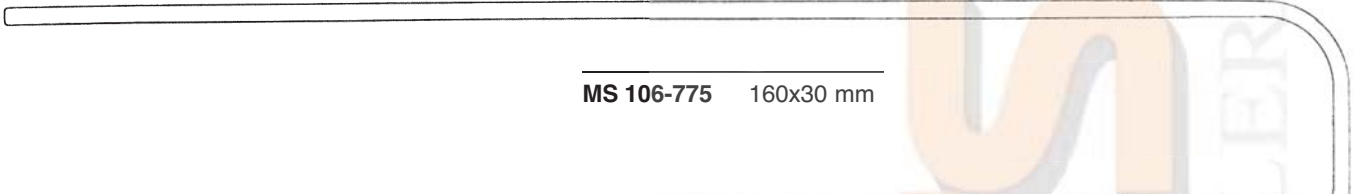

MS 106-775 160x30 mm

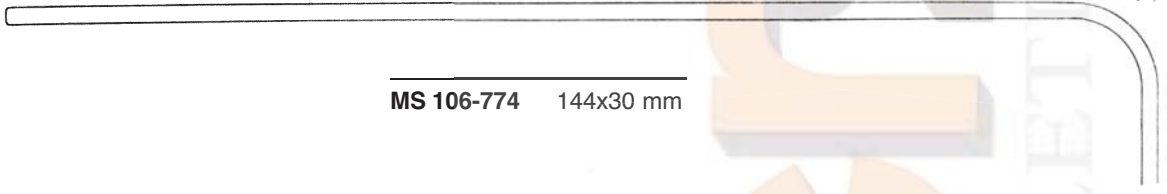

MS 106-774 144x30 mm

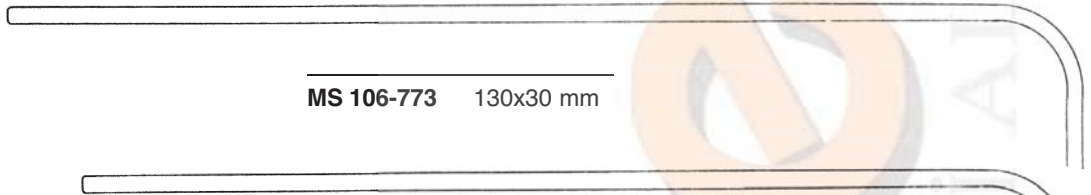

MS 106-773 130x30 mm

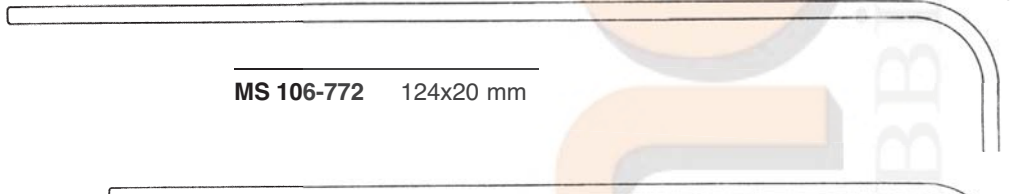

MS 106-772 124x20 mm



MS 106-771 104x25 mm



MS 106-770 84x20 mm



BRUNNER
25,5 cm / 10"



CRAWFORD
19,0 cm / 7¹/₂"

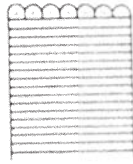

MS 106-780 15x15 mm

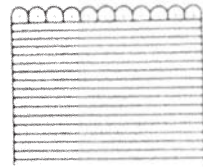

MS 106-781 15x23 mm



ROOS
25,0 cm / 9³/₄"



MS 106-790 Fig. 1



MS 106-791 Fig. 2



MS 106-792 Fig. 3



MS 106-793 Fig. 4



MS 106-794 Fig. 5



MS 106-795 Fig. 6



POLLOSON
MS 106-800 29,0 cm / 11¹/₂"

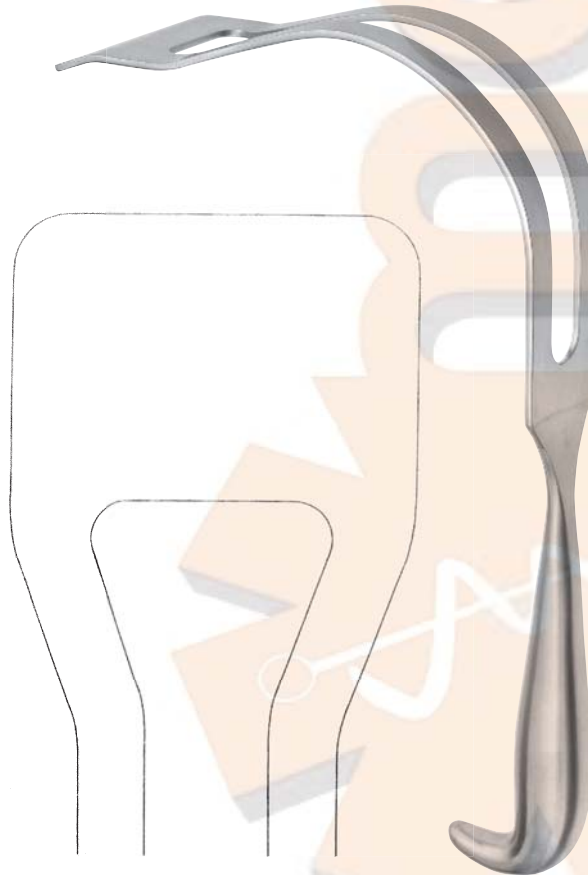

POLLOSON
MS 106-801 27,0 cm / 10³/₄"



HARRINGTON

MS 106-810	31,5 cm / 12 ¹ / ₂ "	
MS 106-811	31,5 cm / 12 ¹ / ₂ "	137x65 mm



MORRIS

MS 106-820	24,5 cm / 9 ² / ₃ "	70x40 mm
MS 106-821	24,5 cm / 9 ² / ₃ "	70x50 mm
MS 106-822	24,5 cm / 9 ² / ₃ "	70x65 mm



MEYERDING
22,5 cm / 8³/₄"

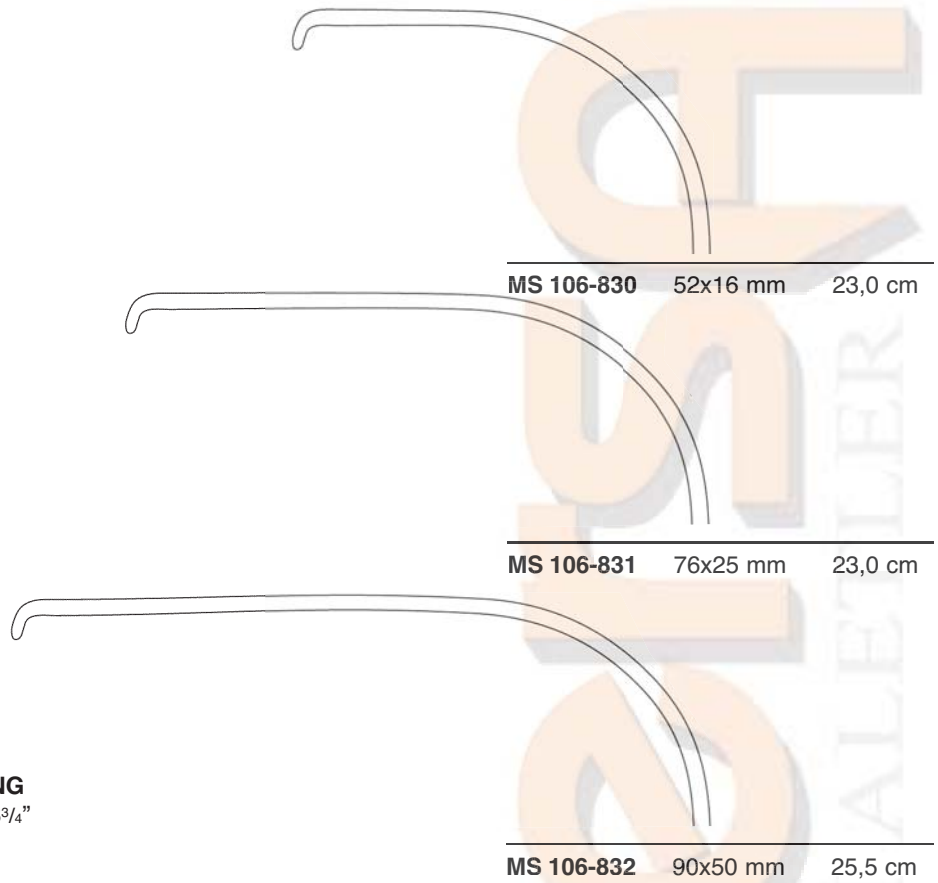

MS 106-830 52x16 mm 23,0 cm

MS 106-831 76x25 mm 23,0 cm

MS 106-832 90x50 mm 25,5 cm



19 mm

DEEVER
MS 106-840 18,0 cm / 7"



22 mm

DEEVER
MS 106-841 21,5 cm / 8¹/₂"

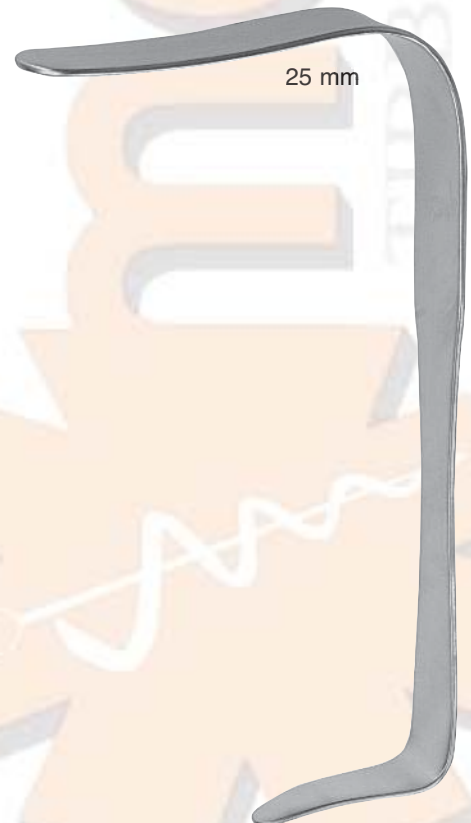

25 mm

DEEVER
MS 106-842 25,0 cm / 9³/₄"



25 mm

DEAVER
MS 106-843 31,0 cm / 12¹/₄"



25 mm

DEAVER
MS 106-844 33,0 cm / 13"



25 mm

DEAVER
MS 106-845 36,0 cm / 14¹/₈"



38 mm

DEAVER
MS 106-846 30,0 cm / 11³/₄"



50 mm

DEAVER
MS 106-847 31,0 cm / 12¹/₄"



75 mm

DEAVER
MS 106-848 31,5 cm / 12¹/₂"



DEAVER

MS 106-860	31,5 cm / 12 ¹ / ₂ "	25 mm
MS 106-861	31,5 cm / 12 ¹ / ₂ "	38 mm
MS 106-862	31,5 cm / 12 ¹ / ₂ "	50 mm
MS 106-863	31,0 cm / 12 ¹ / ₄ "	75 mm



48 x 48 mm

sağ
right

COOLEY

MS 106-870 25,0 cm / 9³/₄"



48 x 48 mm

sağ taraklı
right serrated

COOLEY

MS 106-871 25,0 cm / 9³/₄"



30 x 48 mm

COOLEY

MS 106-872 27,0 cm / 10³/₄"



MIKULICZ

MS 106-880	25,0 cm / 9 ³ / ₄ "	90x35 mm
MS 106-881	25,0 cm / 9 ³ / ₄ "	125 x50 mm
MS 106-882	25,0 cm / 9 ³ / ₄ "	160 x50 mm



MIKULICZ

MS 106-893	26,0 cm / 10 ¹ / ₄ "	90 x 55 mm
-------------------	--	------------



KELLY

MS 106-890	27,0 cm /10 ³ / ₄ "	160x38 mm
MS 106-891	27,0 cm /10 ³ / ₄ "	160x57 mm
MS 106-892	27,0 cm /10 ³ / ₄ "	190x38 mm
MS 106-893	27,0 cm /10 ³ / ₄ "	190x57 mm



ST. MARKS

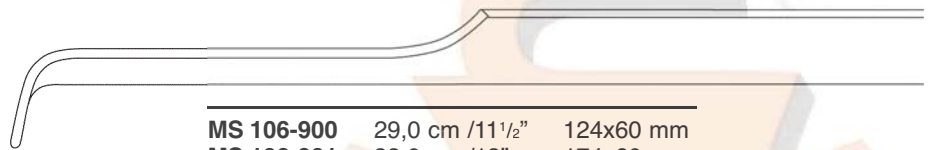

MS 106-900	29,0 cm /11 ¹ / ₂ "	124x60 mm
MS 106-901	33,0 cm /13"	174x60 mm



MS 106-902	33,0 cm /13"	178x60 mm
-------------------	--------------	-----------

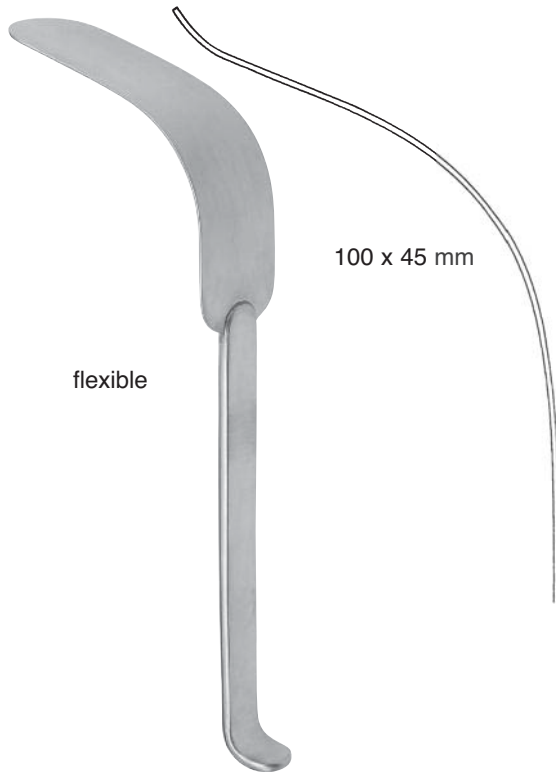

flexible

100 x 45 mm

KUEMMEL

MS 106-910 31,0 cm / 12¹/₄"

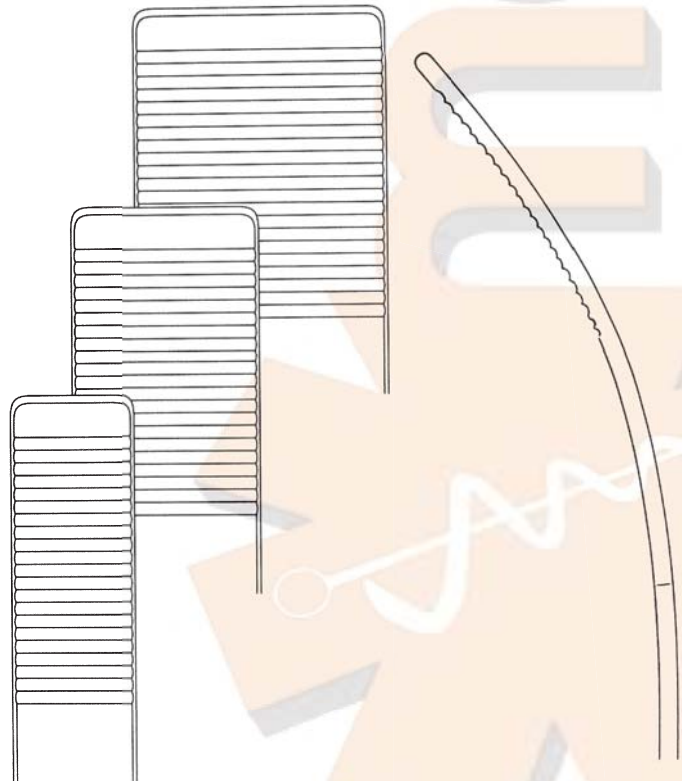

KADER

MS 106-920	28,0 cm / 11"	20 mm
MS 106-921	28,0 cm / 11"	30 mm
MS 106-922	28,0 cm / 11"	40 mm



Fig.1 24x20 mm
Fig.2 29x26 mm
Fig.3 33x29 mm

Fig.1 30x28 mm
Fig.2 36x36 mm
Fig.3 38x43 mm

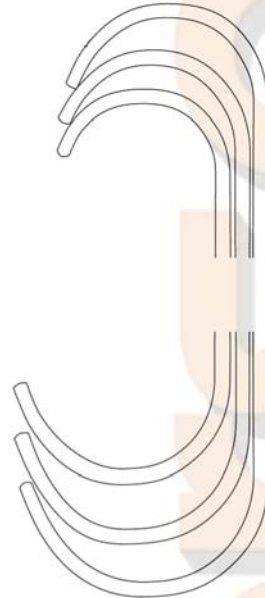

ROUX

MS 106-940	17,0 cm / 6 ³ / ₄	Fig.1-3
MS 106-941	14,0 cm / 5 ¹ / ₂	Fig.1
MS 106-942	15,0 cm / 6	Fig.2
MS 106-943	17,0 cm / 6 ³ / ₄	Fig.3



Fig.2 30x10 mm
Fig.1 26x10 mm

Fig.1 30x13 mm
Fig.2 34x13 mm



FARABEUF

MS 106-950	11,5 cm / 4 ¹ / ₄	Fig.1-2
MS 106-951	11,5 cm / 4 ¹ / ₄	Fig.1
MS 106-952	11,5 cm / 4 ¹ / ₄	Fig.2



Fig.1 23x16 mm
Fig.2 27x16 mm

Fig.1 26x16 mm
Fig.2 30x16 mm



FARABEUF

MS 106-953	15,0 cm / 6	Fig.1-2
MS 106-954	15,0 cm / 6	Fig.1
MS 106-955	15,0 cm / 6	Fig.2



MINI-ROUX
MS 106-970 14,0 cm / 5 1/2"



BABY-ROUX
MS 106-971 13,0 cm / 5"

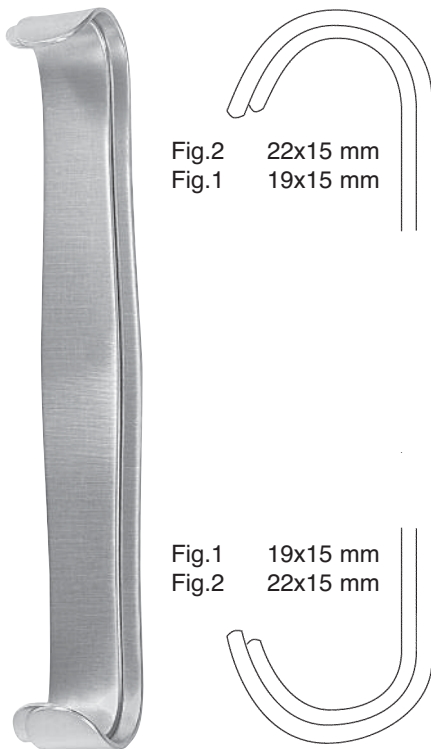

PARKER
MS 106-980 13,5 cm / 5 1/4" Fig.1-2
MS 106-981 13,5 cm / 5 1/4" Fig.1
MS 106-982 13,5 cm / 5 1/4" Fig.2

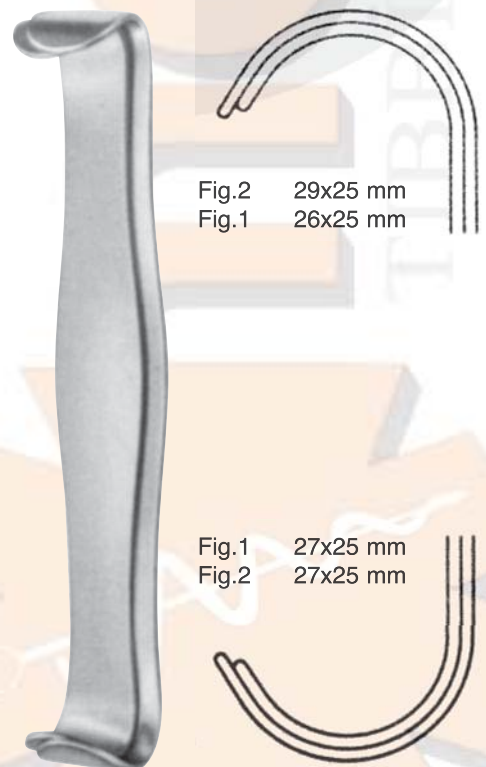

PARKER
MS 106-990 17,5 cm / 7" Fig.1-2
MS 106-991 17,5 cm / 7" Fig.1
MS 106-992 17,5 cm / 7" Fig.2

MATHIEU

MS 106-1000	20,0 cm / 8"	Fig.1-2
MS 106-1001	20,0 cm / 8"	Fig.1
MS 106-1002	20,0 cm / 8"	Fig.2



Fig.2 47x13 mm
Fig.1 42x13 mm

Fig.1 42x26 mm
Fig.2 46x26 mm



40x40 mm

30x30 mm

GOELET

MS 106-1010	19,0 cm / 7½"
--------------------	---------------



Fig.2 25x15 mm
Fig.1 21x15 mm

Fig.1 40x15 mm
Fig.2 45x15 mm

PARKER-LANGENBECK

MS 106-1020	21,5 cm / 8½"	Fig.1-2
MS 106-1021	21,5 cm / 8½"	Fig.1
MS 106-1022	21,5 cm / 8½"	Fig.2



CRILE

MS 106-1030 11,0 cm / 4¹/₄"



LUER

MS 106-1031 11,0 cm / 4¹/₄"



COLLIN

MS 106-1032 14,5 cm / 5³/₄"



REVERDIN
MS 106-1040 29,0 cm / 11½"



REVERDIN
MS 106-1041 28,5 cm / 11"



RIBBON
MS 106-1050 330x30 mm
MS 106-1051 330x40 mm
MS 106-1052 330x50 mm



HABERER
MS 106-1060 200x17/25 mm
MS 106-1061 280x25/30 mm
MS 106-1062 300x37/45 mm



RIBBON
MS 106-1070 200x12 mm
MS 106-1071 200x17 mm
MS 106-1072 200x25 mm



FINSEN

MS 106-1080
5,0 cm / 2"

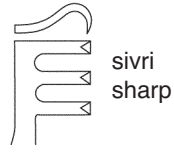

sivri
sharp

MS 106-1082
5,0 cm / 2"

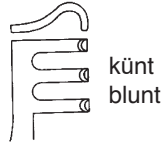

künt
blunt



sivri
sharp

MS 106-1081
7,0 cm / 2³/₄"

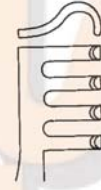

künt
blunt

MS 106-1083
7,0 cm / 2³/₄"



FINSEN

7,0 cm / 2³/₄"

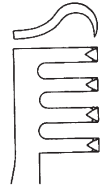

sivri
sharp

MS 106-1084

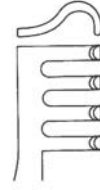

künt
blunt

MS 106-1085

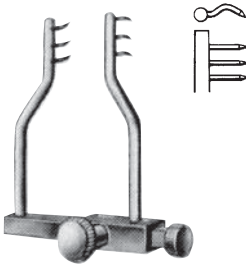

LOGAN

MS 106-1090 4,0 cm / 1¹/₂"



BUCKLEY

MS 106-1091 6,0 cm / 2¹/₄"



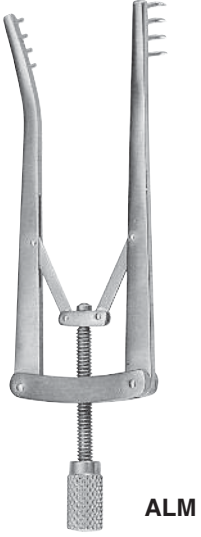

ALM

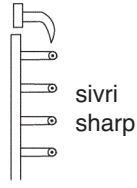

sivri
sharp

MS 106-1100 7,0 cm / 2³/₄"
MS 106-1101 10,0 cm / 4"

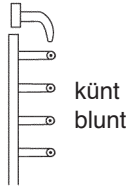

künt
blunt

MS 106-1102 7,0 cm / 2³/₄"
MS 106-1103 10,0 cm / 4"

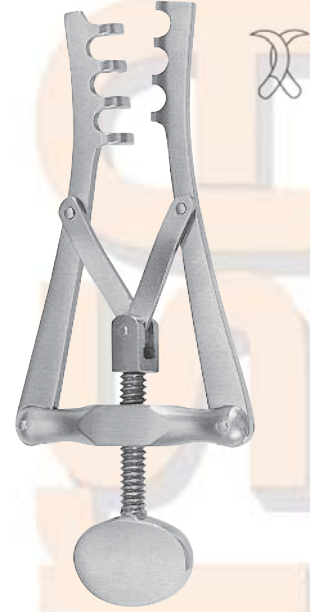

ALLPORT

MS 106-1110 9,5 cm / 3³/₄"



HOLZHEIMER
10,0 cm / 4"

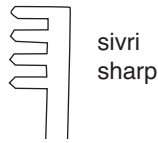

sivri
sharp

MS 106-1115

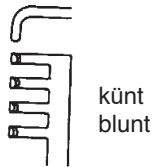

künt
blunt

MS 106-1116



JANSEN
10,0 cm / 4"

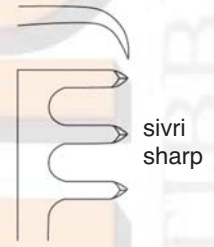

sivri
sharp

MS 106-1120

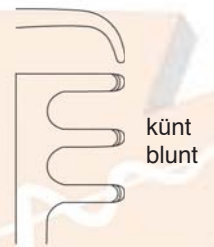

künt
blunt

MS 106-1121



SCALP-CONTOUR
14,0 cm / 5 1/2"



sivri
sharp

MS 106-1140



künt
blunt

MS 106-1141



ANDERSON-ADSON
MS 106-1142 20,0 cm / 8"

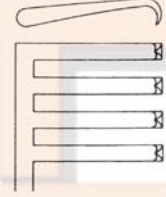

sivri
sharp



ADSON
26,5 cm / 10 1/2"

sivri
sharp

MS 106-1143

künt
blunt

MS 106-1144



WEITLANER-LOKTITE
11,0 cm / 4 3/8"



sivri
sharp

MS 106-1145



künt
blunt

MS 106-1146



sivri
sharp

MS 106-1148



künt
blunt

MS 106-1149

WEITLANER
13,5 cm / 5¼"



sivri
sharp

MS 106-1149



künt
blunt

MS 106-1150

WEITLANER
16,0 cm / 6¼"



sivri
sharp

MS 106-1151



künt
blunt

MS 106-1152

WEITLANER
20,0 cm / 8"

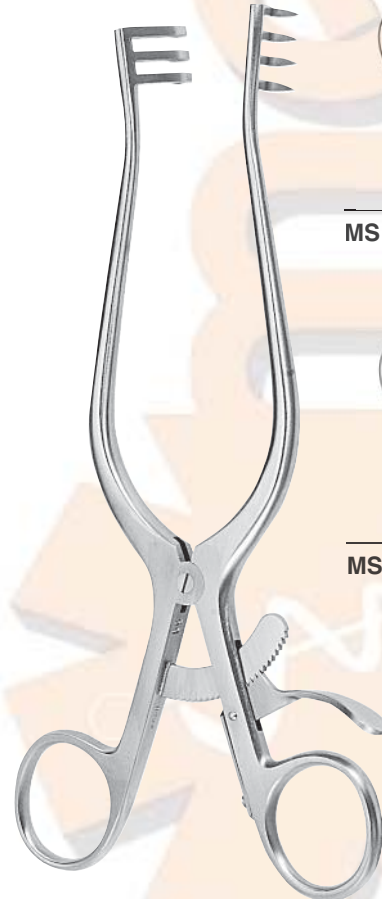

sivri
sharp

MS 106-1153



künt
blunt

MS 106-1154

WEITLANER
24,0 cm / 9½"



WEITLANER-WULLSTEIN
13,0 cm / 5"

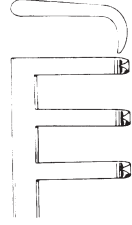

sivri
sharp

MS 106-1155

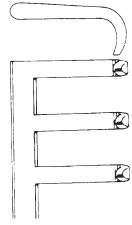

künt
blunt

MS 106-1156

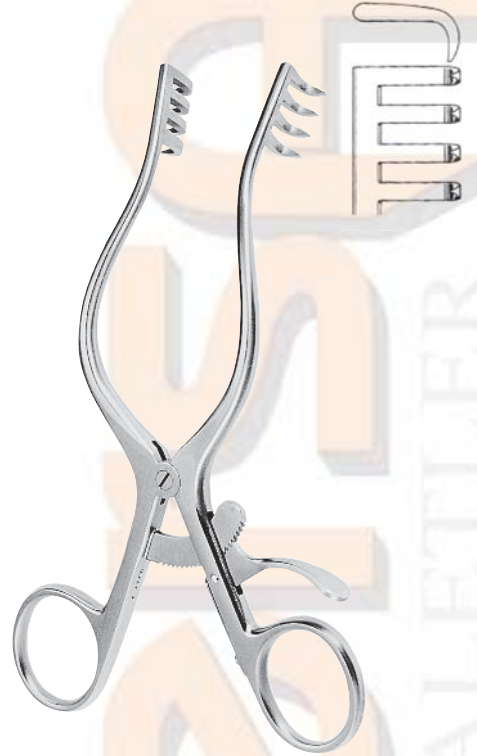

MOLLISON
MS 106-1157 15,5 cm / 6"

sivri
sharp



PLESTER
13,0 cm / 5"

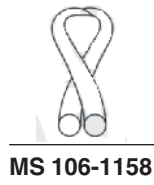

sivri
sharp

MS 106-1158



künt
blunt

MS 106-1159



PLESTER
MS 106-1160 11,0 cm / 4³/₈"

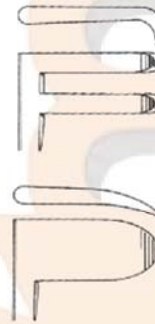

PLESTER
MS 106-1161 11,0 cm / 4³/₈"

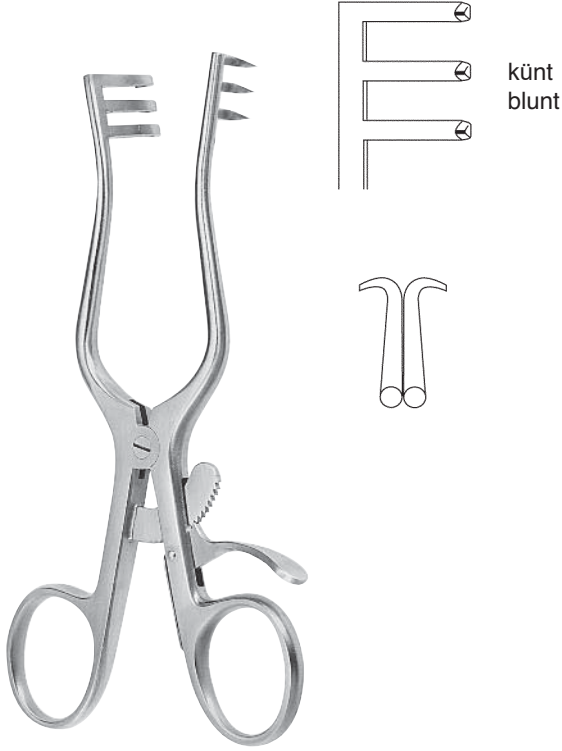

MILLIGAN

MS 106-1170 13,0 cm / 5"



WEITLANER-BABY

MS 106-1171 13,0 cm / 5"

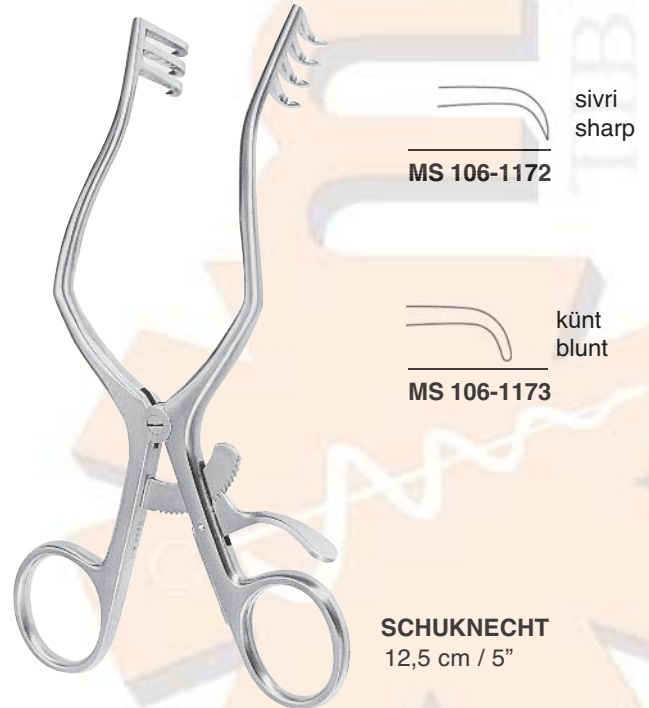

MS 106-1172

MS 106-1173

SCHUKNECHT

12,5 cm / 5"



sivri
sharp

MS 106-1182 19x16 mm

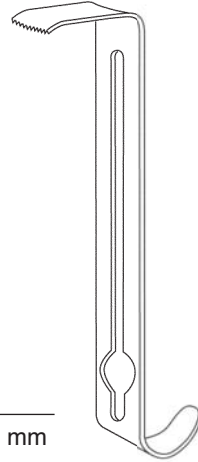
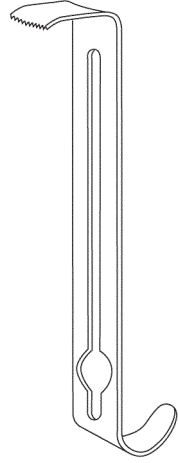

MS 106-1183 25x16 mm



MS 106-1184 32x16 mm



künt
blunt

HENLEY

MS 106-1180 16,0 cm / 6¹/₄"



sivri
sharp

HENLEY

MS 106-1181 16,0 cm / 6¹/₄"



künt
blunt

ADSON

MS 106-1190 13,5 cm / 5¹/₄"
MS 106-1191 16,5 cm / 6¹/₂"

ADSON

MS 106-1192 13,5 cm / 5¹/₄"
MS 106-1193 16,5 cm / 6¹/₂"

sivri
sharp

künt
blunt



ADSON

MS 106-1194 20,0 cm / 8"
MS 106-1195 26,0 cm / 10¹/₄"

ADSON

MS 106-1196 20,0 cm / 8"
MS 106-1197 26,0 cm / 10¹/₄"

sivri
sharp

künt
blunt

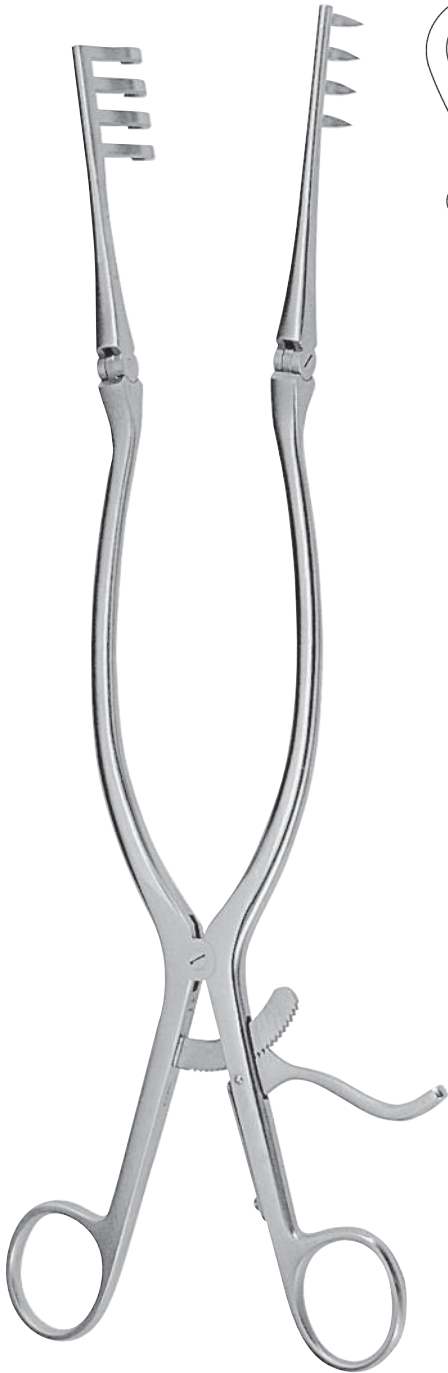

BECKMANN

MS 106-1210 32,0 cm / 12 1/2"

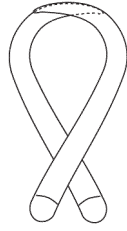

ADSON

MS 106-1211 33,0 cm / 13"



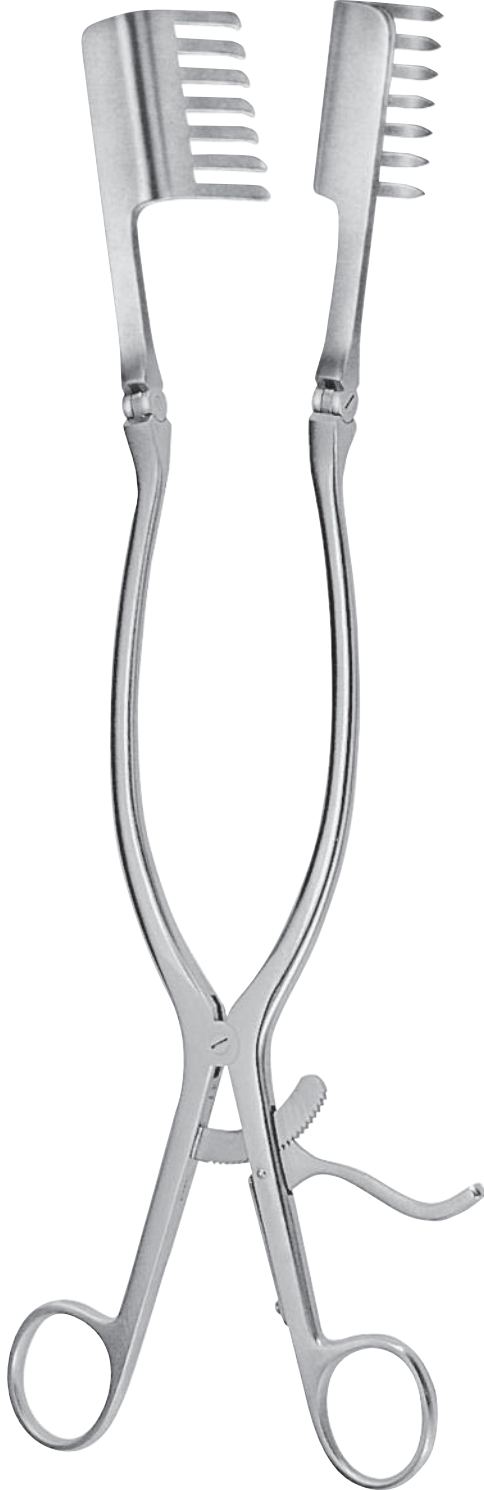

BECKMANN-EATON

MS 106-1212 32,0 cm / 12¹/₂"

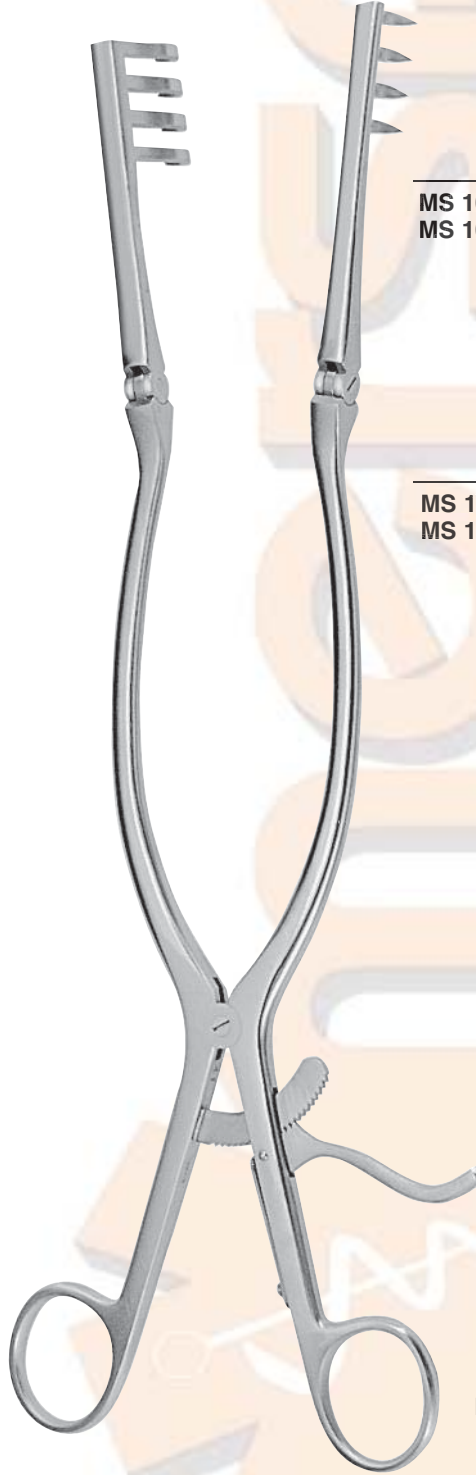

MS 106-1213 25x25 mm
MS 106-1214 25x45 mm



MS 106-1215 25x25 mm
MS 106-1216 25x45 mm

BECKMANN-ADSON

30,5 cm / 12¹/₄"



NORFOLK AND NORWICH
MS 106-1230 22,0 cm / 8³/₄"

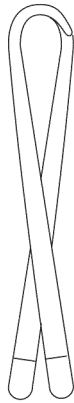

RICHTER
MS 106-1231 17,0 cm / 6³/₄"



MAYO-ADAMS

MS 106-1232 16,5 cm / 6½"



RIGBY

MS 106-1233 18,0 cm / 7"



JOLL (FRIEDMAN)

MS 106-1234 15,5 cm / 6"



GELPI

MS 106-1235 9,0 cm / 3 1/2"
MS 106-1236 11,0 cm / 4 3/8"



GELPI

MS 106-1237 13,0 cm / 5 3/8"



GELPI

MS 106-1238 16,0 cm / 6 1/4"
MS 106-1239 18,0 cm / 7"



GELPI-LOKTITE

MS 106-1240 19,0 cm / 7 1/2"

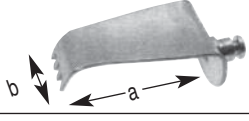

MS 106-1252 40x15-23 mm (axb)



MS 106-1253 45x15-23 mm (axb)



MS 106-1254 50x15-23 mm (axb)



MS 106-1255 55x15-23 mm (axb)



MS 106-1256 60x15-23 mm (axb)

CLOWARD

MS 106-1250

Komple set içindikiler:

- 1 Dağıtıcı (MS 106-1251)
- 2 Yan bladler 40 x 15 - 23 mm (MS 106-1252)
- 2 Yan bladler 45 x 15 - 23 mm (MS 106-1253)
- 2 Yan bladler 50 x 15 - 23 mm (MS 106-1254)
- 2 Yan bladler 55 x 15 - 23 mm (MS 106-1255)
- 2 Yan bladler 60 x 15 - 23 mm (MS 106-1256)

Self-retaining retractor, complete, consisting of:

- 1 Spreader (MS 106-1251)
- 2 Lateral valves, serrated, 40x15 - 23 mm (MS 106-1252)
- 2 Lateral valves, serrated, 45x15 - 23 mm (MS 106-1253)
- 2 Lateral valves, serrated, 50x15 - 23 mm (MS 106-1254)
- 2 Lateral valves, serrated, 55x15 - 23 mm (MS 106-1255)
- 2 Lateral valves, serrated, 60x15 - 23 mm (MS 106-1256)

← 80 mm →



CLOWARD

MS 106-1251 25,0 cm / 9³/₄"

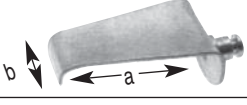

MS 106-1272 40x15-23 mm (axb)



MS 106-1273 45x15-23 mm (axb)



MS 106-1274 50x15-23 mm (axb)



MS 106-1275 55x15-23 mm (axb)



MS 106-1276 60x15-23 mm (axb)

CLOWARD

MS 106-1270

Komple set içindekiler:

- 1 Dağıtıcı (MS 106-1271)
- 2 Yan bladler 40 x 15 - 23 mm (MS 106-1272)
- 2 Yan bladler 45 x 15 - 23 mm (MS 106-1273)
- 2 Yan bladler 50 x 15 - 23 mm (MS 106-1274)
- 2 Yan bladler 55 x 15 - 23 mm (MS 106-1275)
- 2 Yan bladler 60 x 15 - 23 mm (MS 106-1276)

Self-retaining retractor, complete, consisting of:

- 1 Spreader (MS 106-1271)
- 2 Lateral valves, blunt, 40x15 - 23 mm (MS 106-1272)
- 2 Lateral valves, blunt, 45x15 - 23 mm (MS 106-1273)
- 2 Lateral valves, blunt, 50x15 - 23 mm (MS 106-1274)
- 2 Lateral valves, blunt, 55x15 - 23 mm (MS 106-1275)
- 2 Lateral valves, blunt, 60x15 - 23 mm (MS 106-1276)



CLOWARD

MS 106-1271 15,0 cm /6"



BABY-COLLIN

MS 106-1290 18,0 cm / 7"



COLLIN

MS 106-1293 22,5 cm / 9"

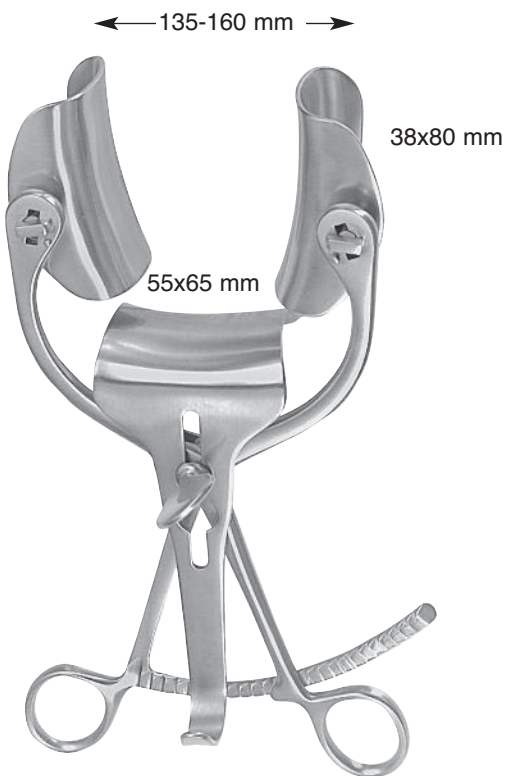

COLLIN

MS 106-1294 22,5 cm / 9 1/4"

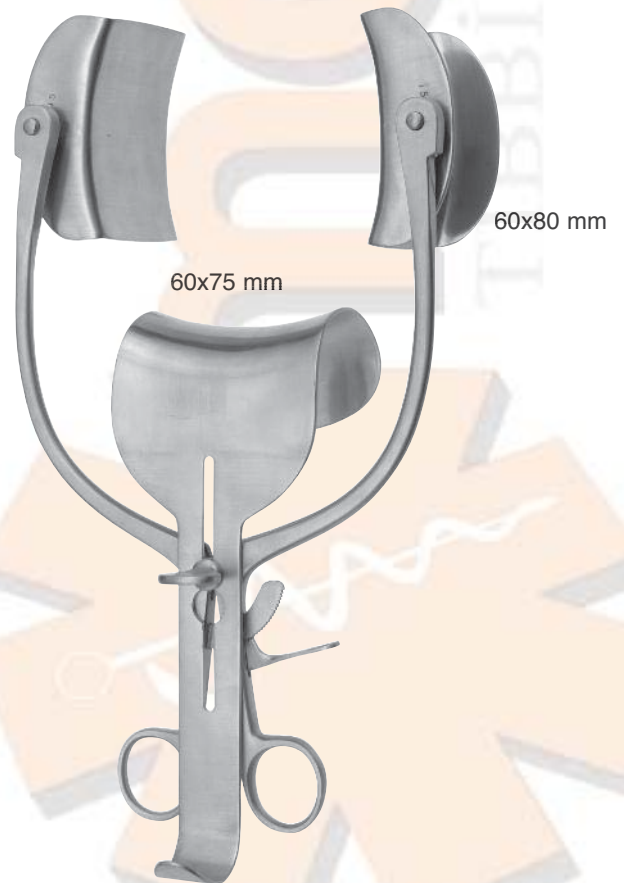

COLLIN-LOKTITE

MS 106-1295 31,0 cm / 12 1/4"

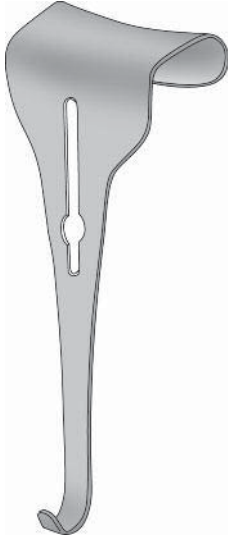

COLLIN

- MS 106-1310 55x55 mm
- MS 106-1311 55x65 mm
- MS 106-1312 55x75 mm

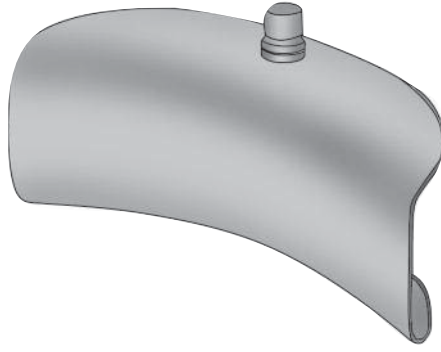

- MS 106-1313 32x 62 mm
- MS 106-1314 38x 80 mm
- MS 106-1315 38x100 mm

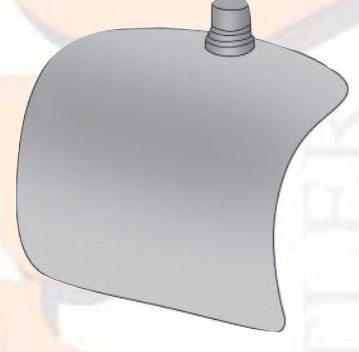

- MS 106-1316 60x80 mm



RICARD

- MS 106-1317 55x70 mm
- MS 106-1318 90x80 mm



- MS 106-1319 50x58 mm
- MS 106-1320 60x80 mm
- MS 106-1321 72x85 mm

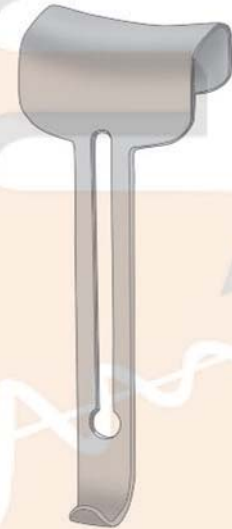

ROBIN-MASSE

- MS 106-1322 40x64 mm

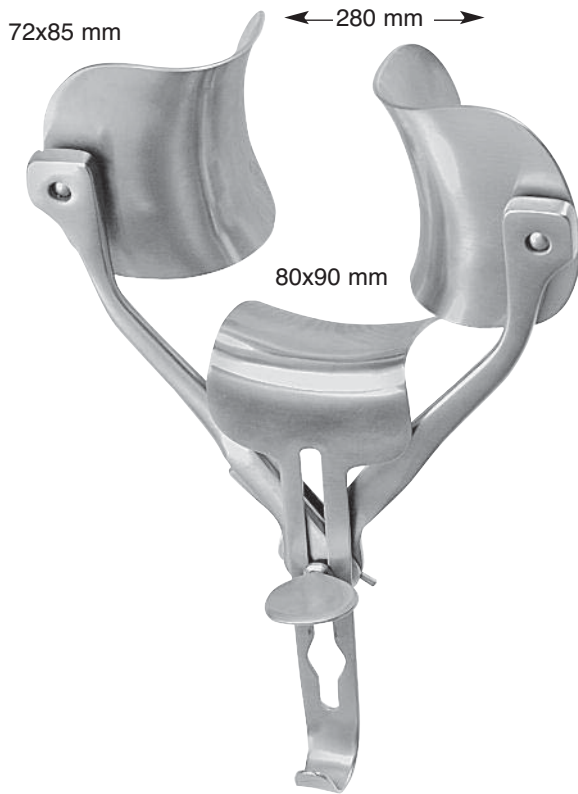

RICARD
MS 106-1330 28,0 cm / 11"



RICARD
MS 106-1331 30,0 cm / 12"



ROBIN-MASSE
MS 106-1332

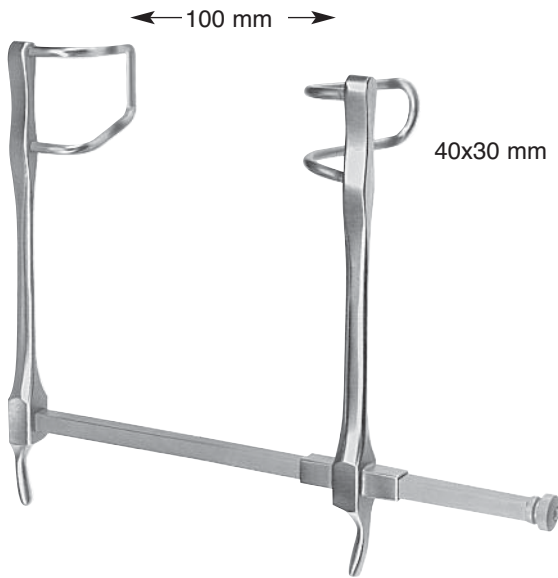

GOSSET
MS 106-1340

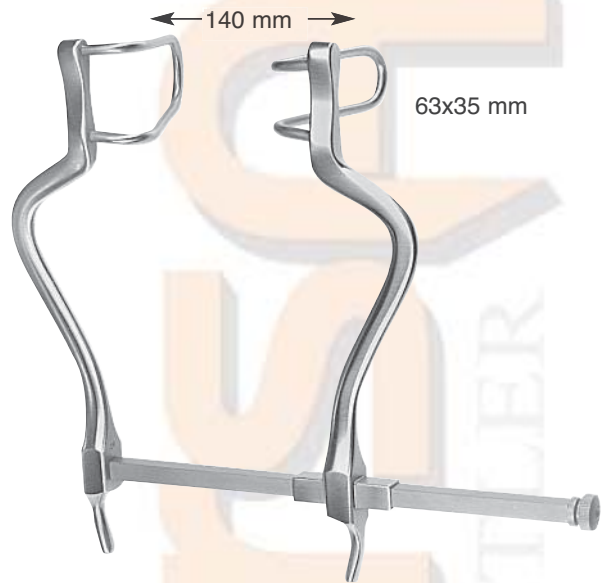

GOSSET
MS 106-1341

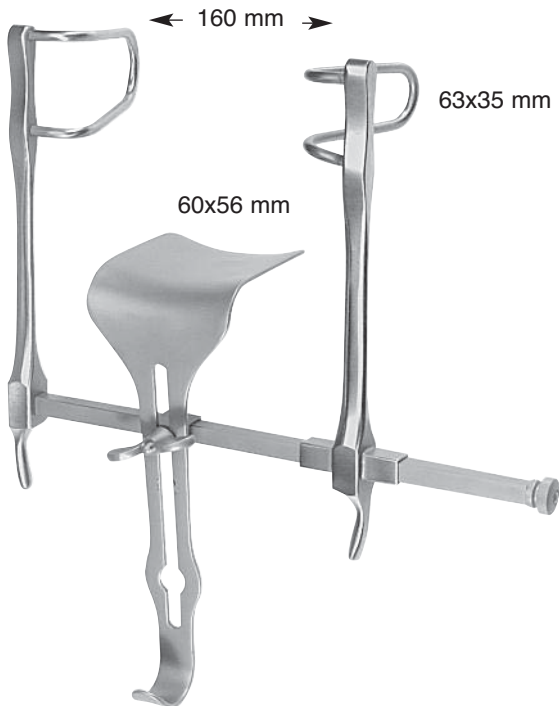

GOSSET
MS 106-1342

MS 106-1343 60x56 mm

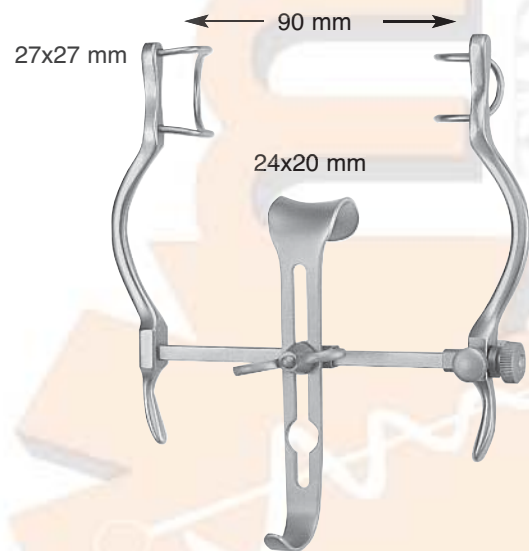

BABY-BALFOUR
MS 106-1344

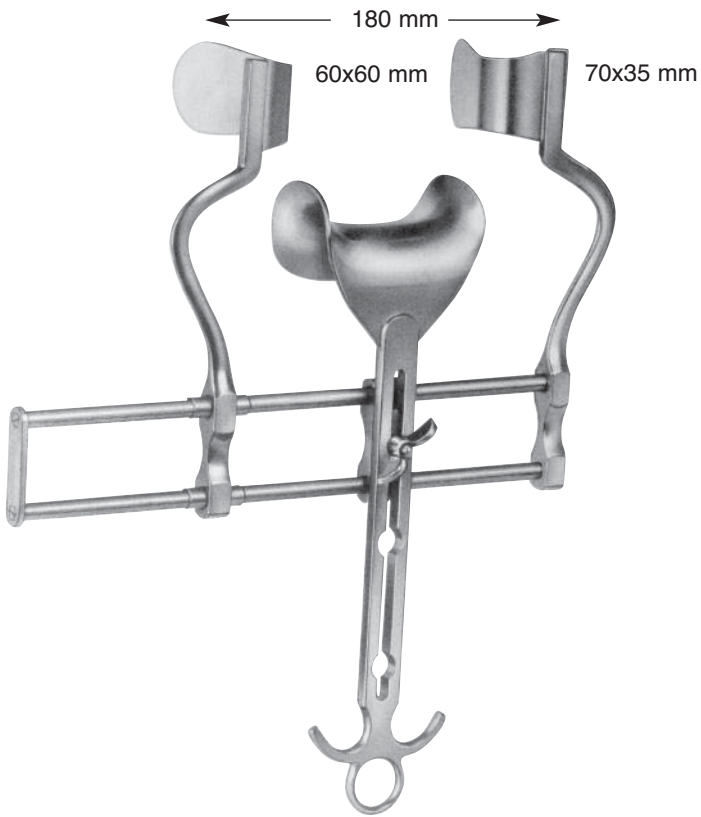

BALFOUR
MS 106-1350

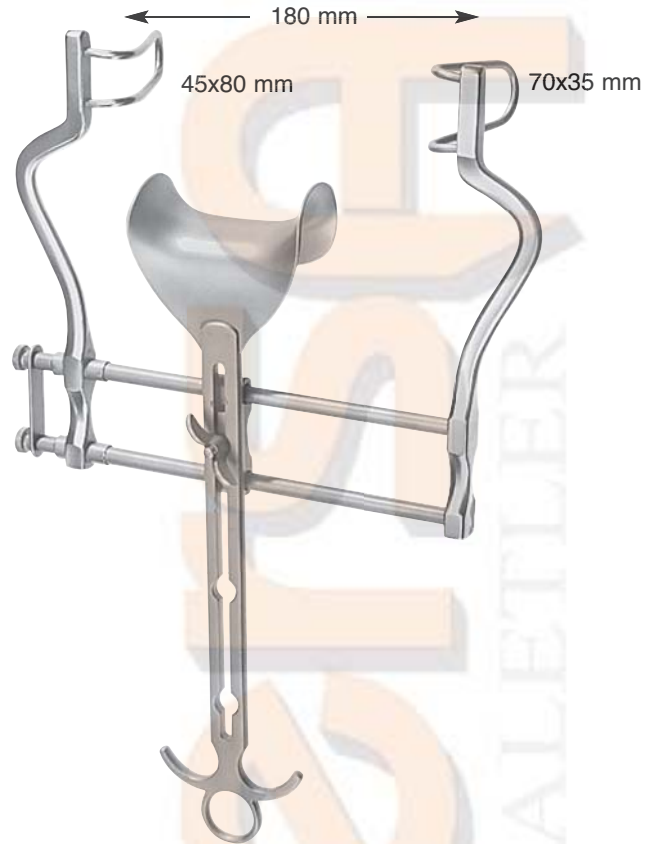

BALFOUR
MS 106-1351

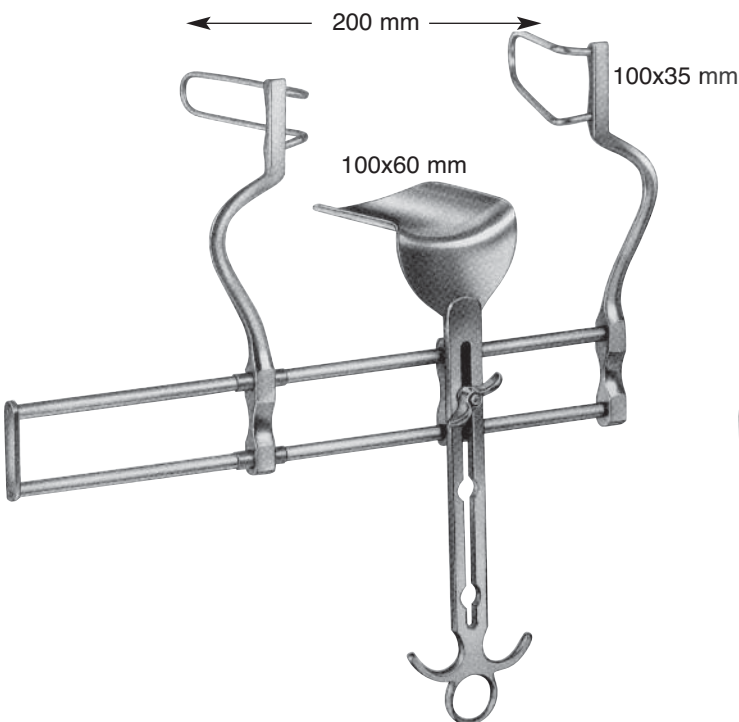

BALFOUR
MS 106-1352

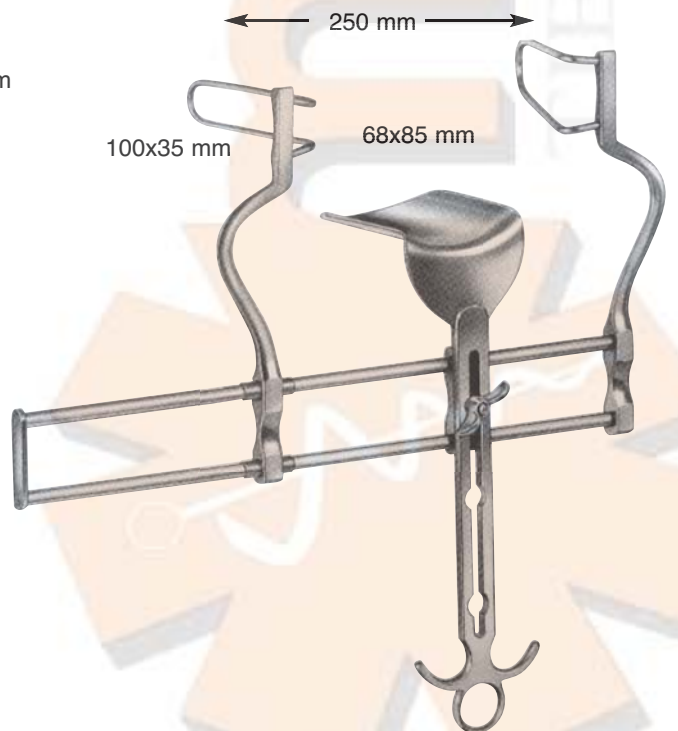

BALFOUR
MS 106-1353

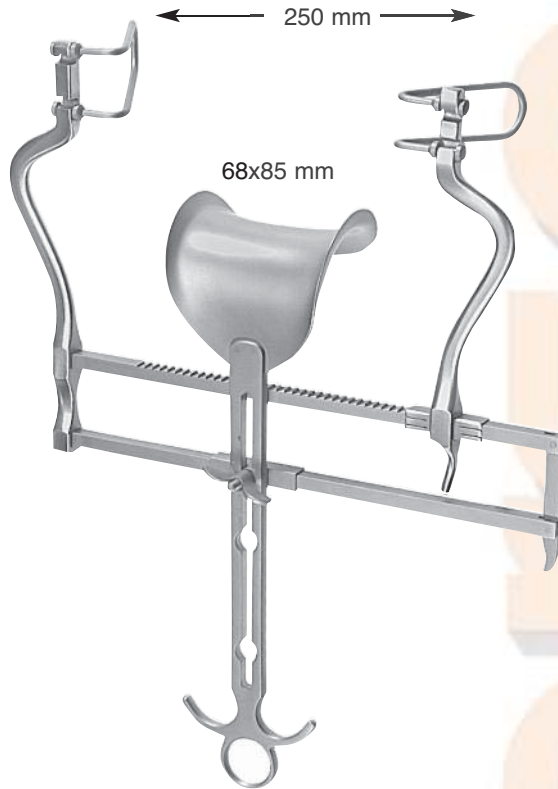

BALFOUR US-TYPE
MS 106-1354

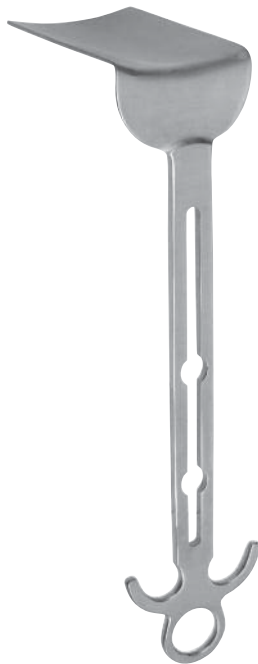

BALFOUR
MS 106-1355 100x60 mm



BALFOUR
MS 106-1356 45x80 mm
MS 106-1357 68x85 mm

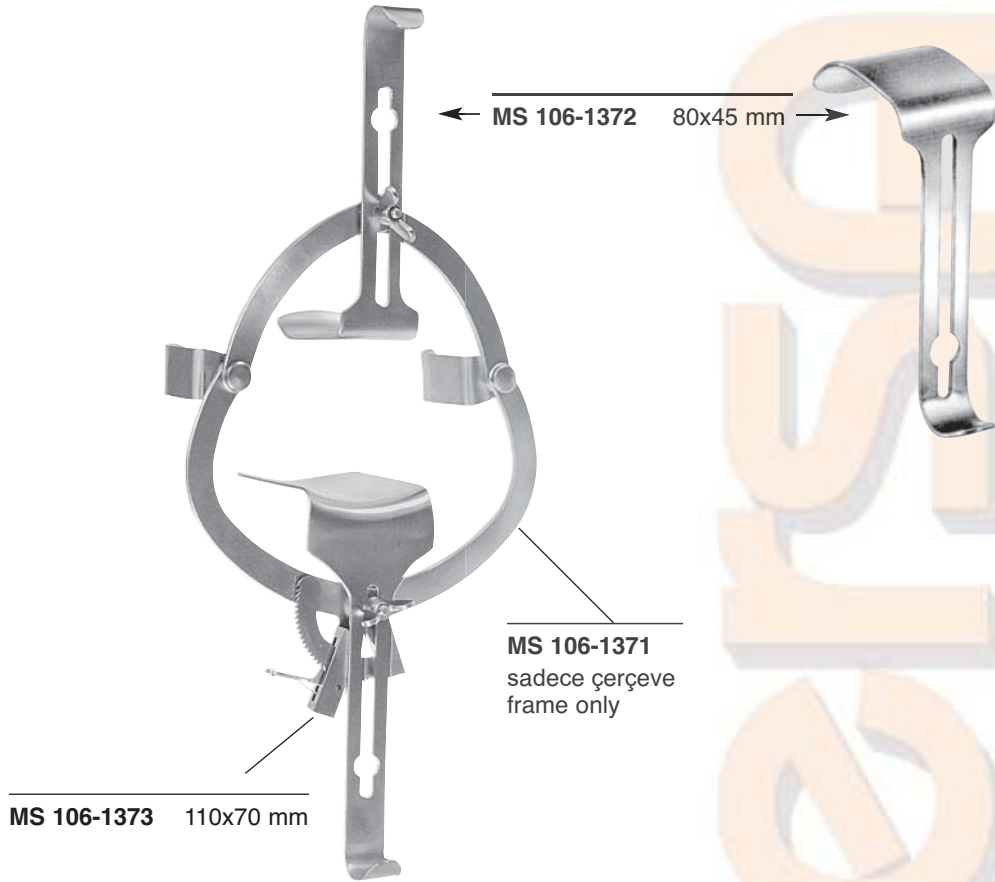

O'SULLIVAN-O'CONNOR

MS 106-1370

Komple set, complete
1 x MS 106-1371
2 x MS 106-1372
1 x MS 106-1373

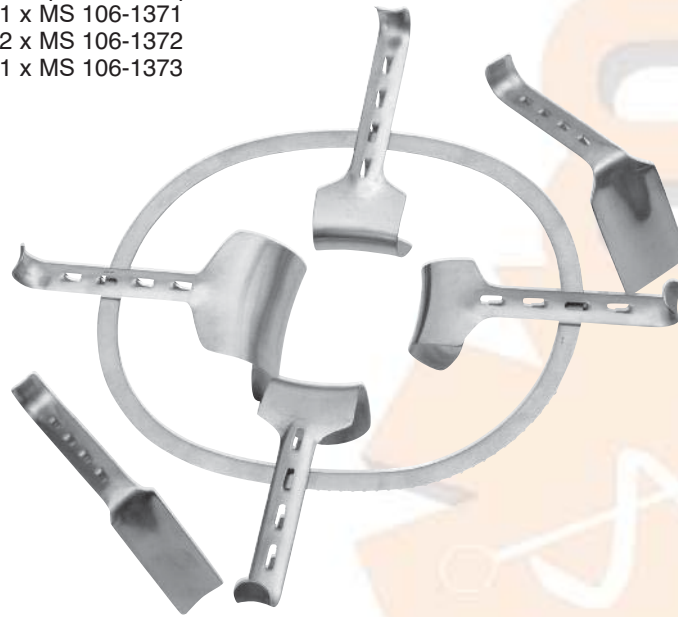

KIRSCHNER

MS 106-1380

Komple set, complete
1 x MS 106-1381
3 x MS 106-1385
1 x MS 106-1386
1 x MS 106-1390
1 x MS 106-1391

MS 106-1381 300 x 240 mm

sadece çerçeve
frame only

MS 106-1385 50x65 mm

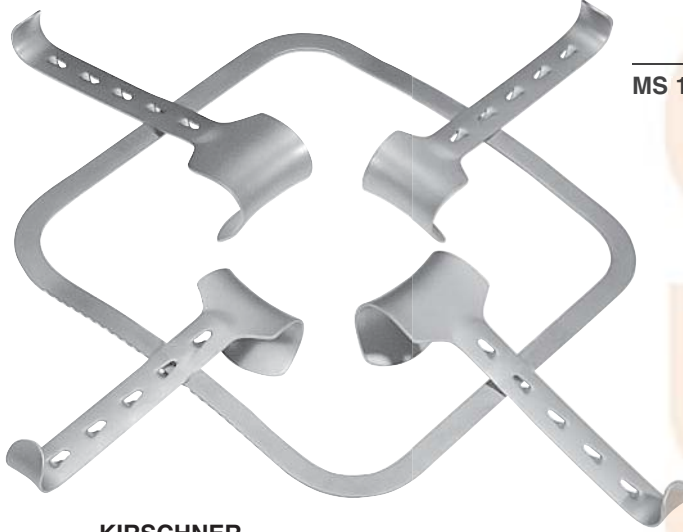

MS 106-1384 40x55 mm

MS 106-1383 240x240 mm
sadece çerçeve
frame only

KIRSCHNER

MS 106-1382
Komple set, complete
1 x MS 106-1383
2 x MS 106-1384
2 x MS 106-1385



KIRSCHNER
MS 106-1386 80x90 mm
MS 106-1387 90x65 mm



KIRSCHNER
MS 106-1388 60x85 mm



KIRSCHNER-BALFOUR
MS 106-1389 80x80 mm



KIRSCHNER
MS 106-1390 98x50 mm
MS 106-1391 105x35 mm

KIRSCHNER

MS 106-1392 270x270 mm
komple set, complete
1 x MS 106-1393
2 x MS 106-1384
2 x MS 106-1385

MS 106-1393 270x270 mm
katlanabilir çerçeve
folding frame, only

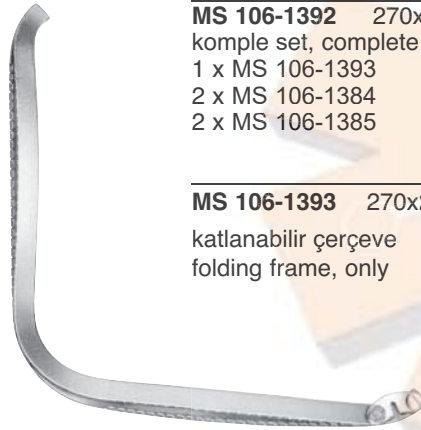

MS 106-1405 45x57 mm

MS 106-1404 83x94 mm

MS 106-1401 275x250 mm
sadece çerçeve
frame only

MS 106-1402 98x50 mm

MS 106-1403 105x35 mm

SEMM

MS 106-1400

komple set, complete
1 x MS 106-1401
1 x MS 106-1402
1 x MS 106-1403
1 x MS 106-1404
2 x MS 106-1405
1 x MS 106-1406

MS 106-1406 50x54 mm

MS 106-1417 40x40 mm

MS 106-1416 40x30 mm

MS 106-1412 255x180 mm

MS 106-1413 150x180 mm

sadece çerçeve
frame only

40x40 mm

DENIS-BROWNE

MS 106-1410

1 x MS 106-1413
2 x MS 106-1416
2 x MS 106-1417

DENIS-BROWNE

MS 106-1411

1 x MS 106-1412
2 x MS 106-1416
2 x MS 106-1417

MS 106-1414 20x30 mm

MS 106-1415 20x40 mm

MS 106-1434 40x60 mm

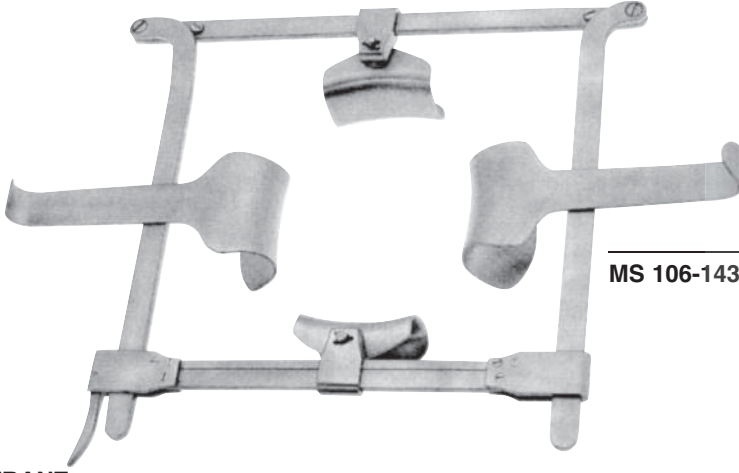

MS 106-1432 48x56 mm



MS 106-1434 40x60 mm
MS 106-1435 40x80 mm

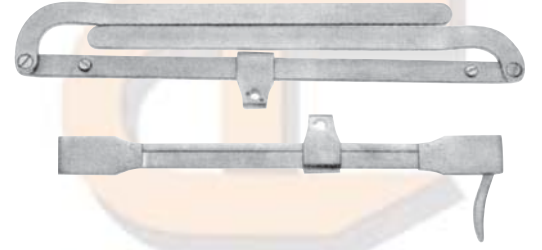

MS 106-1431 220x220 mm
katlanabilir çerçeve
folding frame, only

MS 106-1432 48x56 mm
MS 106-1433 50x85 mm

FRANZ

MS 106-1430

komple set, complete

1 x 016-840-001

2 x 016-840-002

2 x 016-840-004



DOYEN

MS 106-1450 28,0 cm /11" 90x50 mm

MS 106-1451 28,0 cm /11" 105x50 mm

MS 106-1452 28,0 cm /11" 120x50 mm

MS 106-1453 28,0 cm /11" 135x50 mm



MS 106-1460 79,0 cm /31"



ROCHARD
MS 106-1461



ROCHARD
MS 106-1462



ROCHARD
MS 106-1463 19,0 cm /11"

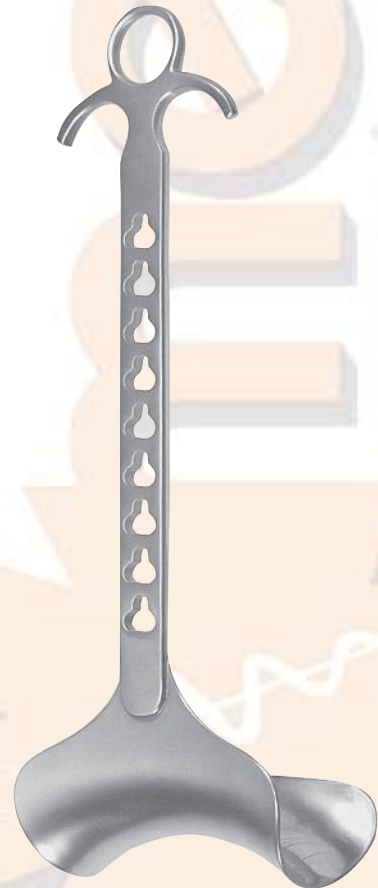

ROCHARD

MS 106-1464	28,0 cm /11"	95x50 mm
MS 106-1465	28,0 cm /11"	105x50 mm
MS 106-1466	28,0 cm /11"	120x60 mm
MS 106-1467	28,0 cm /11"	135x60 mm
MS 106-1468	28,0 cm /11"	155x60 mm