



104



KLEMPLER
CLAMPS



HALSTED-MOSQUITO



MS 104-101
12,5 cm / 5"



MS 104-102
12,5 cm / 5"

1x2

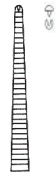

MS 104-105
12,5 cm / 5"

1x2



MS 104-106
12,5 cm / 5"



MS 104-103
14,0 cm / 5 1/2"



MS 104-104
14,0 cm / 5 1/2"

1x2

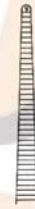

MS 104-107
14,0 cm / 5 1/2"

1x2



MS 104-108
14,0 cm / 5 1/2"



MS 104-120
18,0 cm / 7"



MS 104-121
18,0 cm / 7"

1x2



MS 104-124
18,0 cm / 7"

1x2



MS 104-125
18,0 cm / 7"



MS 104-122
21,0 cm / 8 1/4"



MS 104-123
21,0 cm / 8 1/4"

1x2



MS 104-126
21,0 cm / 8 1/4"

1x2



MS 104-127
21,0 cm / 8 1/4"



HALSTED-MOSQUITO



MICRO-MOSQUITO



MS 104-140
10,0 cm / 4"



MS 104-141
10,0 cm / 4"

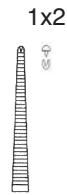

MS 104-144
10,0 cm / 4"



MS 104-145
10,0 cm / 4"



MS 104-142
12,0 cm / 4³/₄"



MS 104-143
12,0 cm / 4³/₄"



MS 104-146
12,0 cm / 4³/₄"



MS 104-147
12,0 cm / 4³/₄"

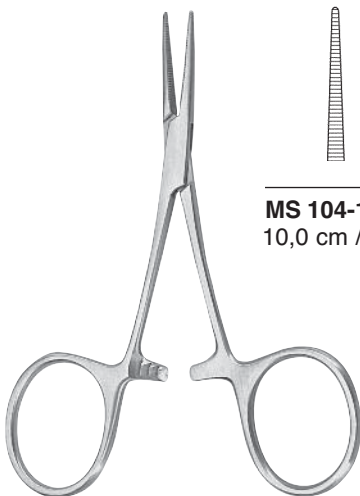

HARTMANN



MS 104-160
10,0 cm / 4"



MS 104-161
10,0 cm / 4"

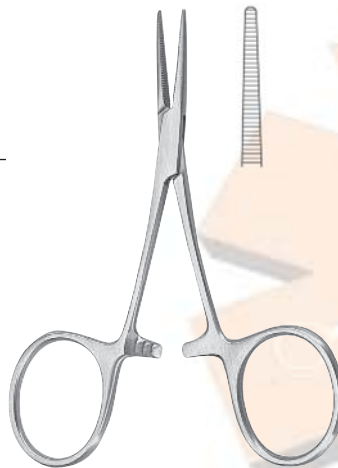

CARREL

MS 104-162 8,5 cm / 3¹/₃"



TERRIER

MS 104-163 8,5 cm / 3¹/₃"





KROENLEIN
MS 104-164 13,0 cm / 5"

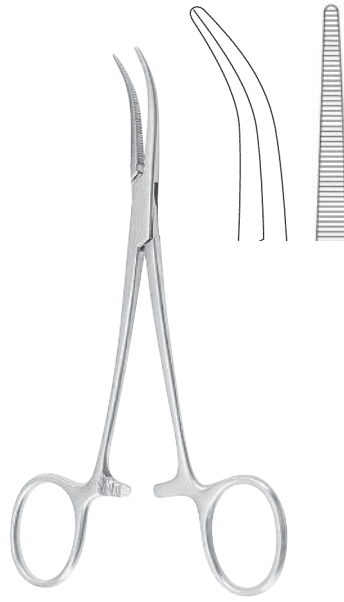

MOSQUITO-DANDY
MS 104-170 12,0 cm / 4³/₄"

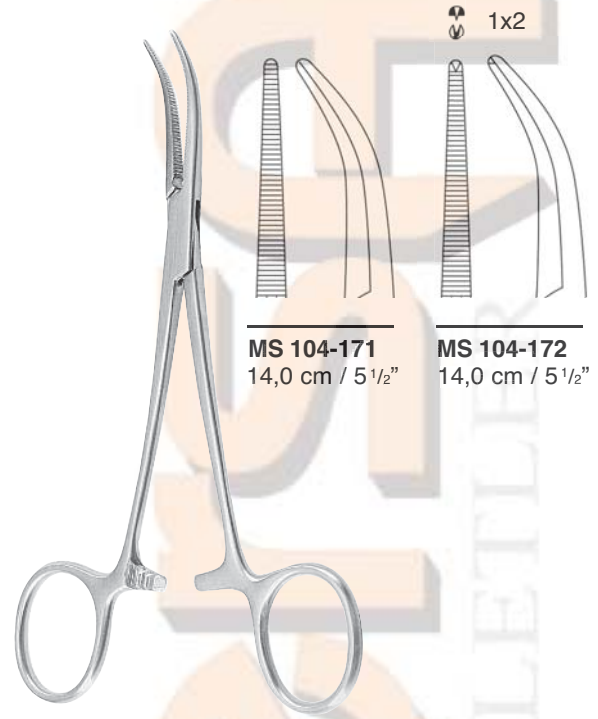

DANDY

MS 104-171
14,0 cm / 5¹/₂"

MS 104-172
14,0 cm / 5¹/₂"



PROVIDENCE-HOSPITAL

MS 104-180
14,0 cm / 5¹/₂"

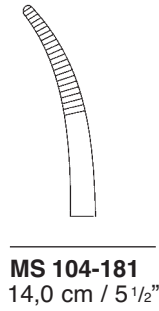

MS 104-181
14,0 cm / 5¹/₂"

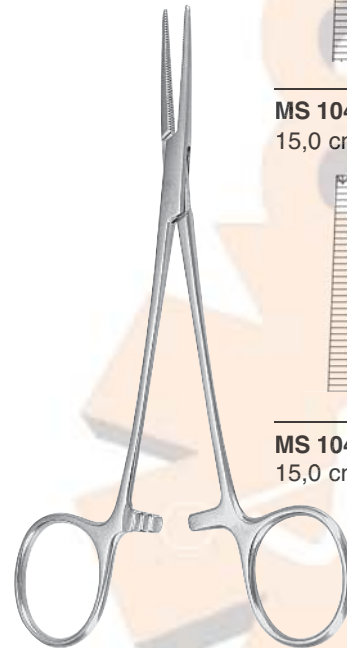

LERICHE

MS 104-190
15,0 cm / 6"

MS 104-191
15,0 cm / 6"



MS 104-192
15,0 cm / 6"



MS 104-193
15,0 cm / 6"

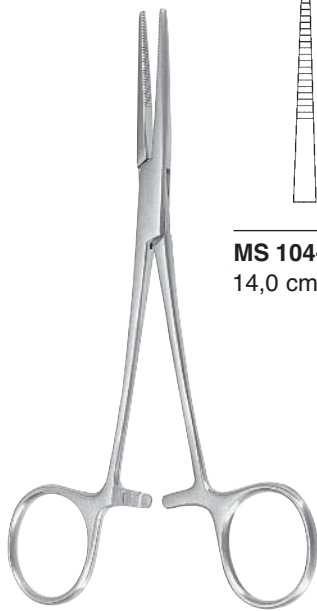

KELLY



MS 104-200
14,0 cm / 5 1/2"

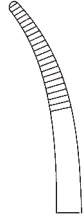

MS 104-201
14,0 cm / 5 1/2"

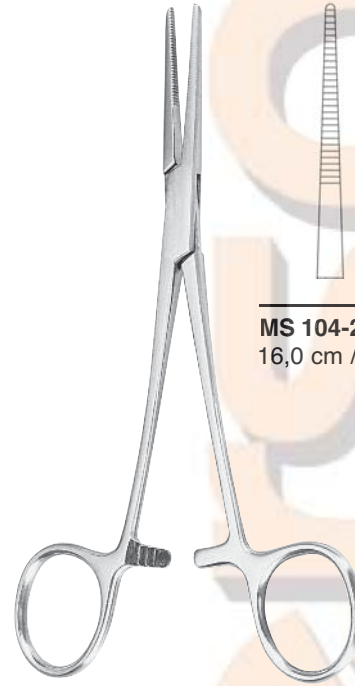

KELLY-RANKIN



MS 104-202
16,0 cm / 6 1/4"



MS 104-203
16,0 cm / 6 1/4"

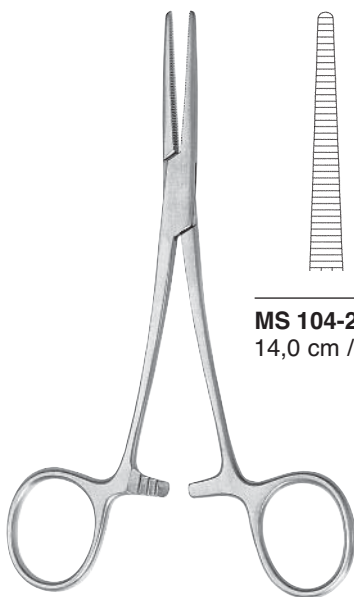

CRILE



MS 104-210
14,0 cm / 5 1/2"

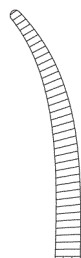

MS 104-211
14,0 cm / 5 1/2"

1x2

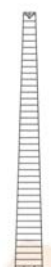

MS 104-212
14,0 cm / 5 1/2"

1x2



MS 104-213
14,0 cm / 5 1/2"



CRILE-RANKIN

MS 104-214
16,0 cm / 6 1/4"

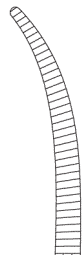

MS 104-215
16,0 cm / 6 1/4"

1x2

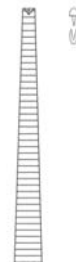

MS 104-216
16,0 cm / 6 1/4"

1x2



MS 104-217
16,0 cm / 6 1/4"



BABY-OVERHOLT

MS 104-230 13,5 cm / 5 1/4"

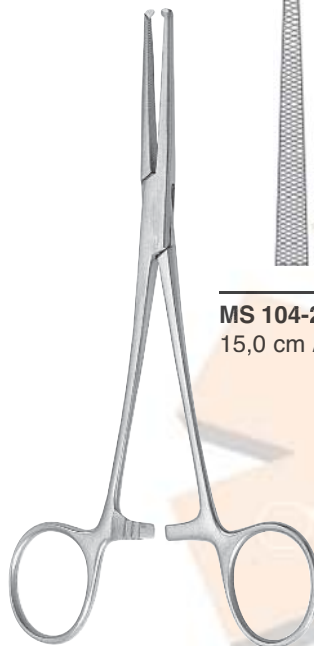
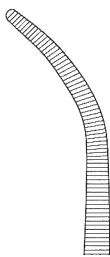

DIXON-LOVELACE

MS 104-231
15,0 cm / 6"



MS 104-232
15,0 cm / 6"



1x2



SPENCER-WELLS



MS 104-240
13,0 cm / 5 1/8"



MS 104-241
15,0 cm / 6"



MS 104-242
18,0 cm / 7"



MS 104-243
20,0 cm / 8"

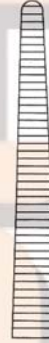

MS 104-244
23,0 cm / 9"



SPENCER-WELLS



MS 104-245
13,0 cm / 5 1/8"



MS 104-246
15,0 cm / 6"



MS 104-247
18,0 cm / 7"



MS 104-248
20,0 cm / 8"



MS 104-249
23,0 cm / 9"



PEAN



MS 104-260
14,0 cm / 5 1/2"



MS 104-261
16,0 cm / 6 1/4"

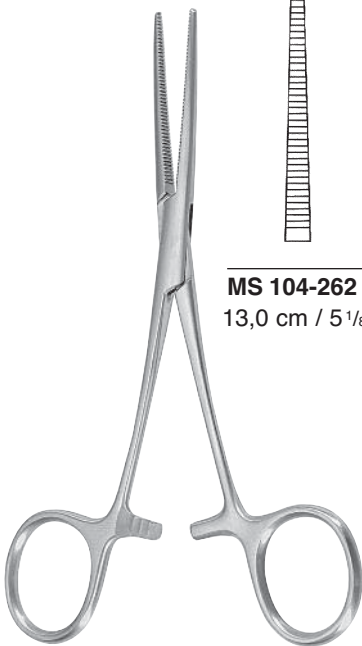

PEAN-DELICATE



MS 104-262
13,0 cm / 5 1/8"



MS 104-263
14,0 cm / 5 1/2"



MS 104-264
16,0 cm / 6 1/4"

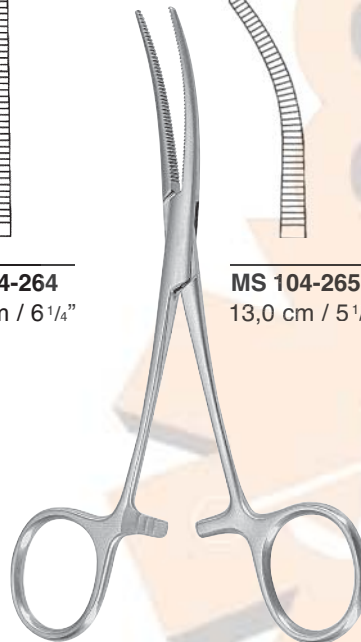

PEAN-DELICATE



MS 104-265
13,0 cm / 5 1/8"



MS 104-266
14,0 cm / 5 1/2"



MS 104-267
16,0 cm / 6 1/4"



ROCHESTER-PEAN



MS 104-280
14,0 cm / 5 1/2"



MS 104-281
16,0 cm / 6 1/4"



MS 104-282
18,0 cm / 7"



MS 104-283
20,0 cm / 8"



MS 104-284
22,0 cm / 8 3/4"



MS 104-285
24,0 cm / 9 1/2"



MS 104-286
26,0 cm / 10 1/4"



MS 104-287
28,0 cm / 11"



MS 104-288
30,0 cm / 11 3/4"



ROCHESTER-PEAN



MS 104-300
14,0 cm / 5 1/2"

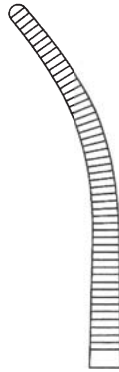

MS 104-301
16,0 cm / 6 1/4"



MS 104-302
18,0 cm / 7"



MS 104-303
20,0 cm / 8"

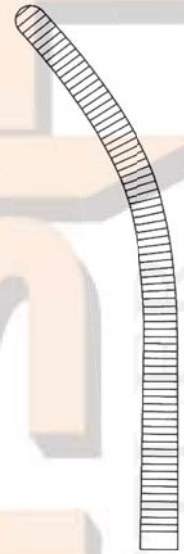

MS 104-304
22,0 cm / 8 3/4"



MS 104-305
24,0 cm / 9 1/2"



MS 104-306
26,0 cm / 10 1/4"

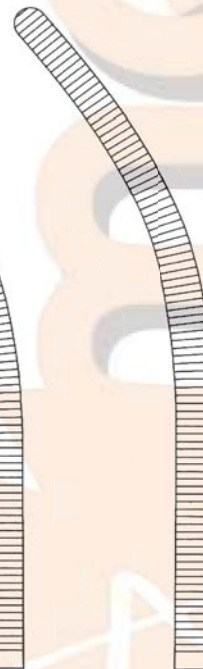

MS 104-307
28,0 cm / 11"

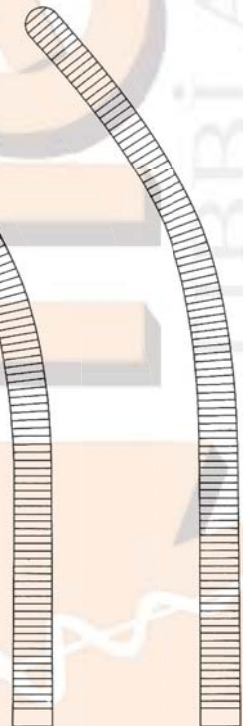

MS 104-308
30,0 cm / 11 3/4"



1x2
↔

KOCHER

MS 104-320 14,5 cm / 5³/₄"

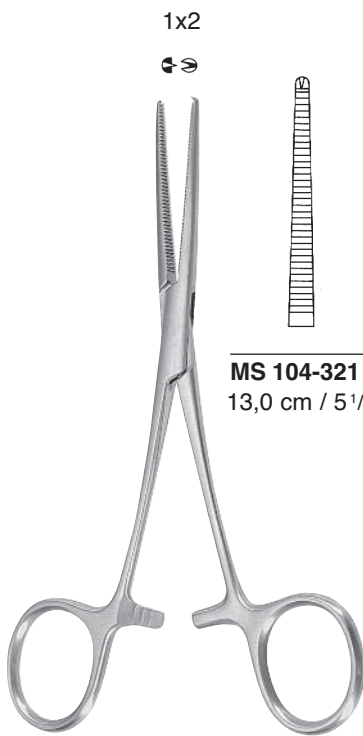

1x2
↔

MS 104-321
13,0 cm / 5¹/₈"

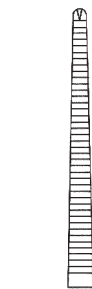

MS 104-322
14,0 cm / 5¹/₂"



MS 104-323
16,0 cm / 6¹/₄"

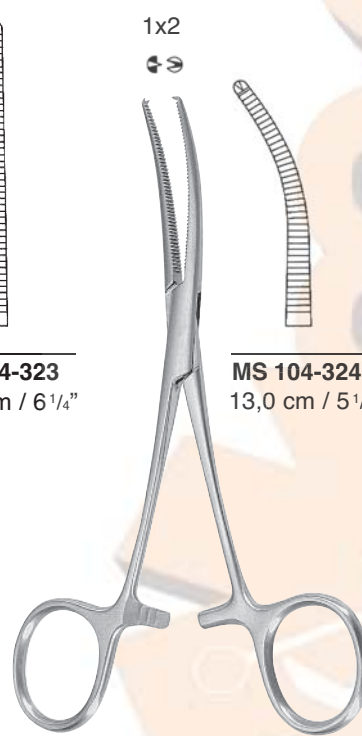

1x2
↔

MS 104-324
13,0 cm / 5¹/₈"



MS 104-325
14,0 cm / 5¹/₂"



MS 104-326
16,0 cm / 6¹/₄"

KOCHER DELICATE

KOCHER DELICATE



1x2



KOCHER-OCHSNER



MS 104-340
13,0 cm / 5 1/8"



MS 104-341
14,0 cm / 5 1/2"



MS 104-342
16,0 cm / 6 1/4"



MS 104-343
18,0 cm / 7"

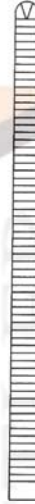

MS 104-344
20,0 cm / 8"



MS 104-345
22,0 cm / 8 3/4"



MS 104-346
24,0 cm / 9 1/2"

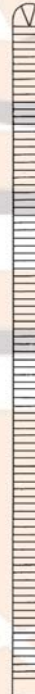

MS 104-347
26,0 cm / 10 1/4"

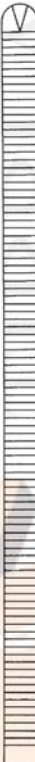

MS 104-348
30,0 cm / 11 3/4"



1x2



KOCHER-OCHSNER



MS 104-360
13,0 cm / 5 1/8"



MS 104-361
14,0 cm / 5 1/2"



MS 104-362
16,0 cm / 6 1/4"



MS 104-363
18,0 cm / 7"

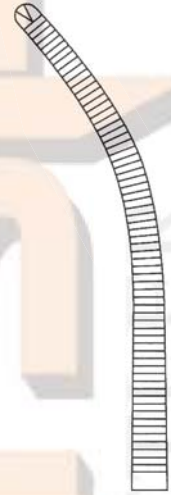

MS 104-364
20,0 cm / 8"

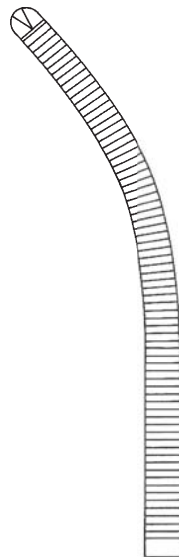

MS 104-365
22,0 cm / 8 3/4"

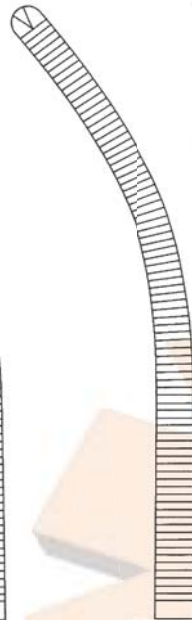

MS 104-366
24,0 cm / 9 1/2"

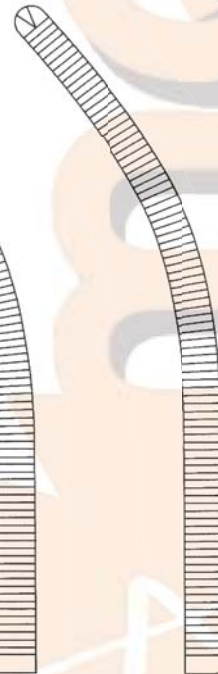

MS 104-367
26,0 cm / 10 1/4"

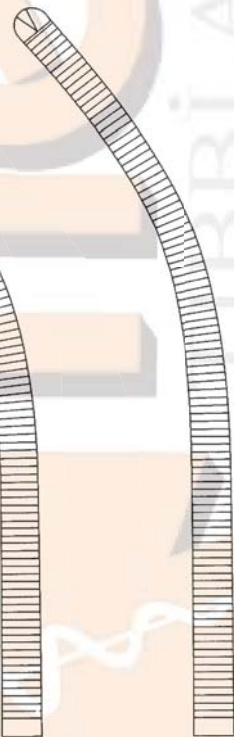

MS 104-368
30,0 cm / 11 3/4"



BENGOLEA



MS 104-380
20,0 cm / 8"

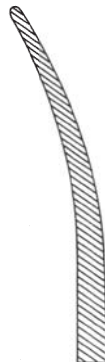

MS 104-381
20,0 cm / 8"



MS 104-382
20,0 cm / 8"



MS 104-383
20,0 cm / 8"



MS 104-384
26,0 cm / 10 1/4"



MS 104-385
26,0 cm / 10 1/4"



MS 104-386
26,0 cm / 10 1/4"



MS 104-387
26,0 cm / 10 1/4"



CHAPUT

MS 104-400 13,0 cm / 5 1/8"



TUFFIER

MS 104-401 13,0 cm / 5 1/8"



PENNINGTON

MS 104-402 15,5 cm / 6 1/8"
MS 104-403 20,0 cm / 8"



COLLIN

MS 104-410 14,0 cm / 5 1/2"



COLLIN



MS 104-411
16,0 cm / 6 1/4"

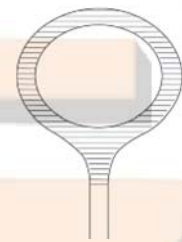

MS 104-412
16,0 cm / 6 1/4"



BUIE
MS 104-420 21,0 cm / 8 1/4"



PRATT
MS 104-421 15,0 cm / 6"



MARTEL
MS 104-422 14,0 cm / 5 1/2"

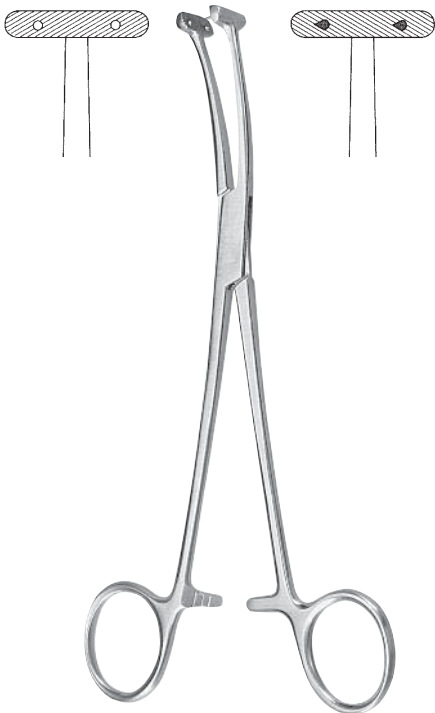

WILLET-MARTEL
MS 104-423 19,0 cm / 7 1/2"

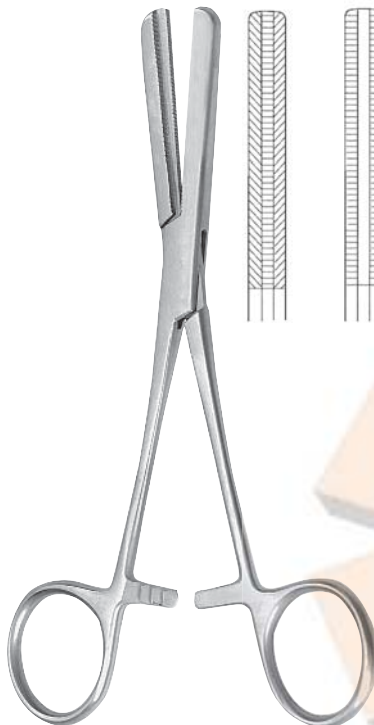

FERGUSSON
MS 104-430 16,0 cm / 6 1/4"
MS 104-431 20,0 cm / 8"

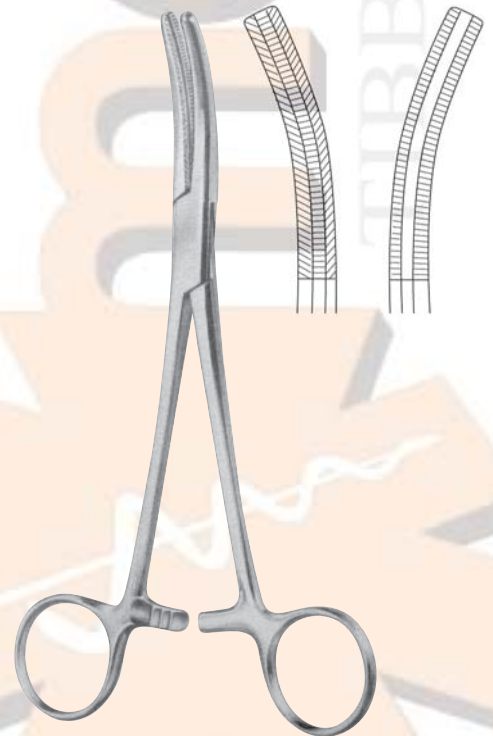

FERGUSSON
MS 104-432 16,0 cm / 6 1/4"
MS 104-433 20,0 cm / 8"



BAINBRIDGE

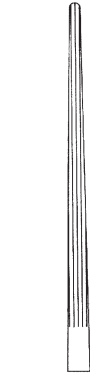

MS 104-440
15,0 cm / 6"



MS 104-441
18,5 cm / 7 1/4"



MS 104-442
15,0 cm / 6"



MS 104-443
18,5 cm / 7 1/4"



ROCHESTER-CARMALT



MS 104-450
16,0 cm / 6 1/4"



MS 104-451
20,0 cm / 8"



MS 104-452
16,0 cm / 6 1/4"

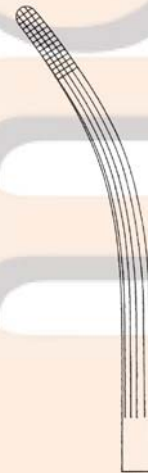

MS 104-453
20,0 cm / 8"



BABY-MIXTER



MS 104-460
14,0 cm / 5 1/2"



MS 104-461
14,0 cm / 5 1/2"



BABY-MIXTER

MS 104-462 18,0 cm / 7"

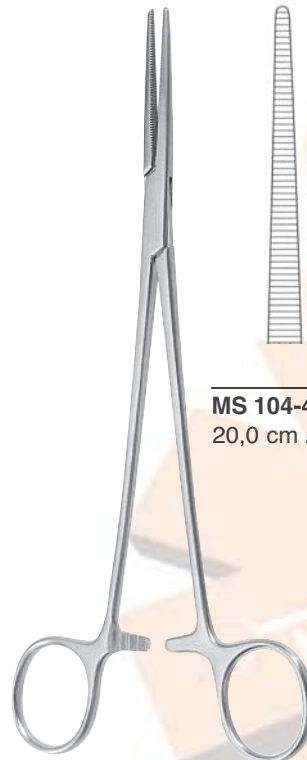
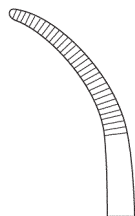

HEISS



MS 104-470
20,0 cm / 8"



MS 104-471
20,0 cm / 8"



MS 104-472
20,0 cm / 8"



SCHNIDT

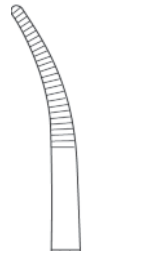

MS 104-480
19,0 cm / 7 1/2"

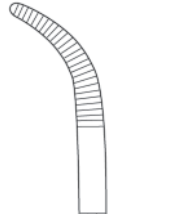

MS 104-481
19,0 cm / 7 1/2"

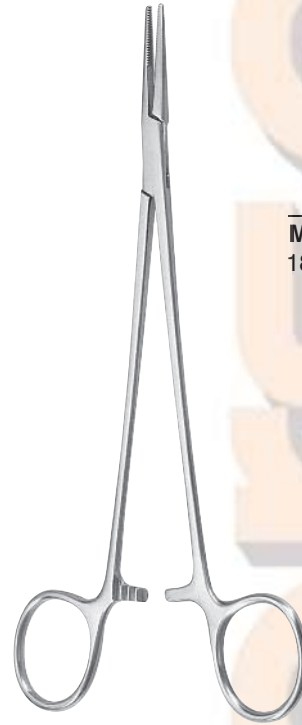

ADSON



MS 104-490
18,5 cm / 7 1/4"

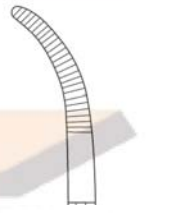

MS 104-491
18,5 cm / 7 1/4"



BABY-ADSON

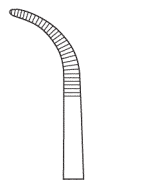

MS 104-500
14,0 cm / 5 1/2"

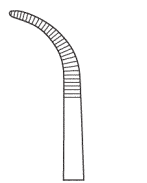

MS 104-501
18,0 cm / 7"



MIKRO-ADSON

MS 104-502 14,0 cm / 5 1/2"

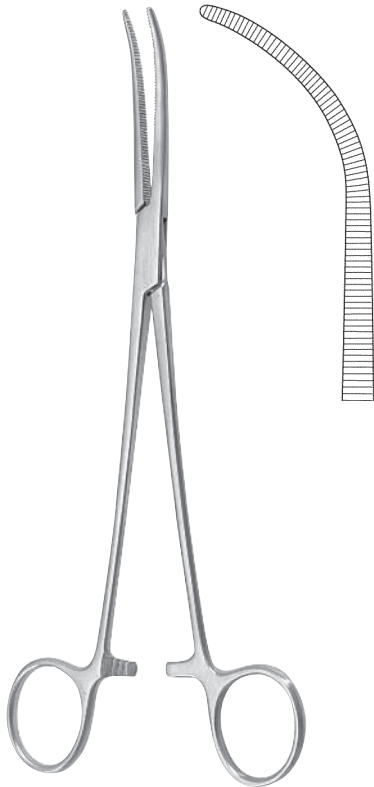

OVERHOLT-MIXTER
MS 104-510 21,0 cm / 8¹/₄"



MS 104-511
19,0 cm / 7¹/₂"

MS 104-512
19,0 cm / 7¹/₂"

BIRKETT

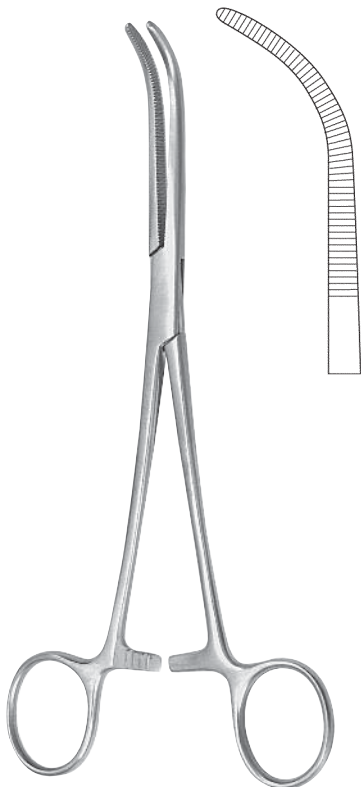

JOHNS HOPKINS
MS 104-513 20,0 cm / 8"

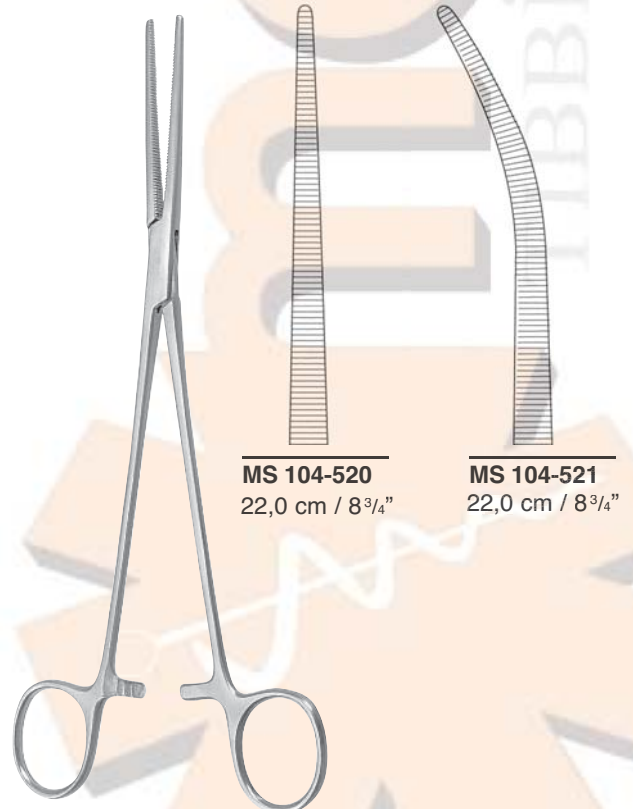

MS 104-520
22,0 cm / 8³/₄"

MS 104-521
22,0 cm / 8³/₄"

ROBERTS

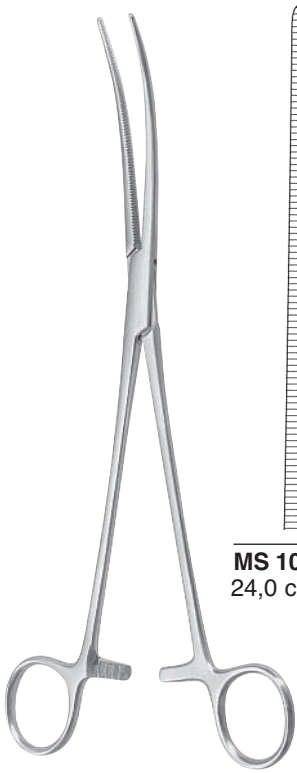

SAROT



MS 104-530
24,0 cm / 9 1/2"

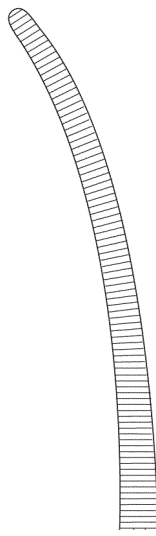

MS 104-531
24,0 cm / 9 1/2"

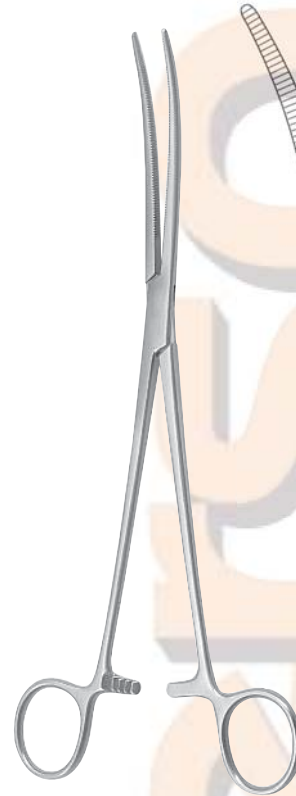

CRAFOORD

MS 104-540 24,0 cm / 9 1/2"

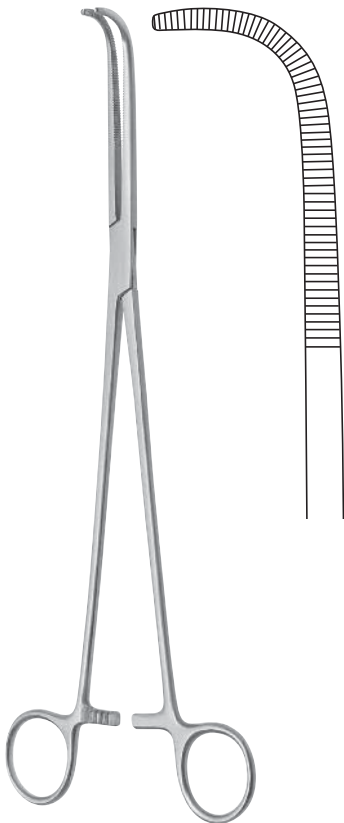

MIXTER-CRAFOORD

MS 104-541 27,0 cm / 10 3/4"



CRAFOORD-SELLORS



MS 104-542
22,0 cm / 8 3/4"



MS 104-543
23,0 cm / 9"



MS 104-544
24,0 cm / 9 1/2"



OVERHOLT

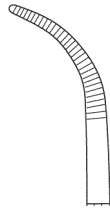

MS 104-560
18,5 cm / 7¹/₄"

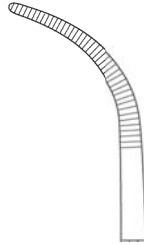

MS 104-561
20,0 cm / 8"

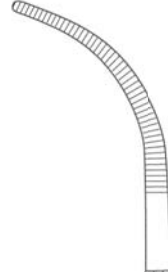

MS 104-562
21,0 cm / 8¹/₄"

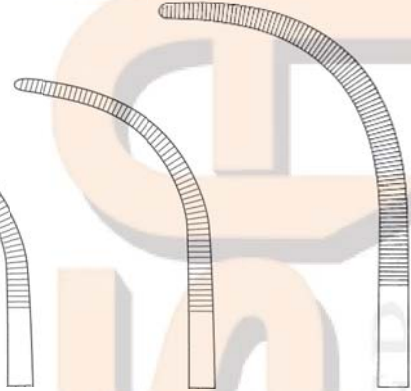

MS 104-563
21,5 cm / 8¹/₂"



MS 104-564
24,0 cm / 9¹/₂"



OVERHOLT-GEISSENDOERFER

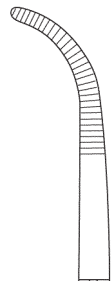

MS 104-580
MS 104-600

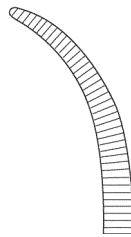

MS 104-281
MS 104-601

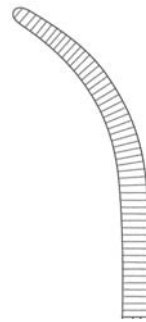

MS 104-582
MS 104-602

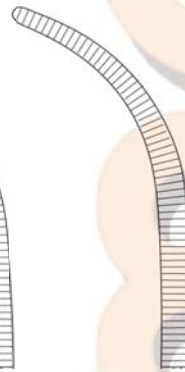

MS 104-583
MS 104-603

21,0 cm / 8¹/₄"
27,0 cm / 10³/₄"

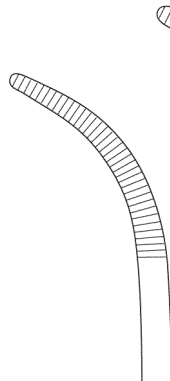

MS 104-584
MS 104-604

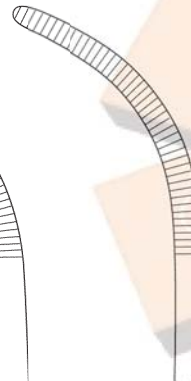

MS 104-585
MS 104-605



MS 104-586
MS 104-606

21,0 cm / 8¹/₄"
27,0 cm / 10³/₄"



RUMEL

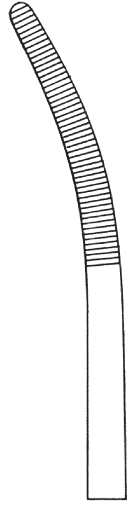

MS 104-620
23,0 cm / 9"

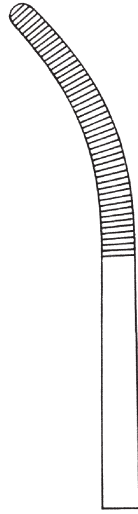

MS 104-621
23,0 cm / 9"

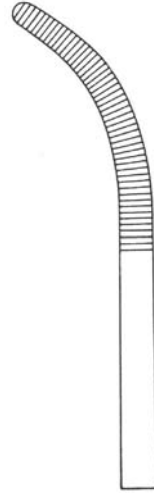

MS 104-622
23,0 cm / 9"



MS 104-623
23,0 cm / 9"



MS 104-624
23,0 cm / 9"



MINI-GEMINI

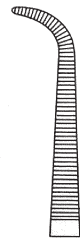

MS 104-640
18,0 cm / 7"



MS 104-641
22,0 cm / 8³/₄"



MS 104-642
25,0 cm / 9³/₄"



MS 104-643
28,0 cm / 11"



GEMINI

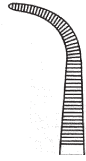

MS 104-660
18,0 cm / 7"



MS 104-661
16,0 cm / 6 1/4"



MS 104-662
13,0 cm / 5 1/8"



MS 104-663
20,0 cm / 8"

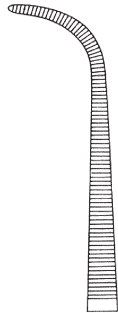

MS 104-664
23,0 cm / 9"

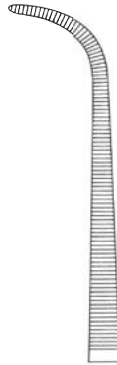

MS 104-665
25,0 cm / 9 3/4"



MS 104-666
28,0 cm / 11"



TOENNIS



MS 104-690
MS 104-694

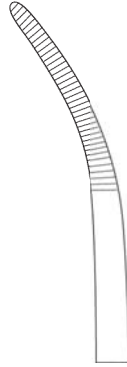

MS 104-691
MS 104-695



MS 104-692
MS 104-696



MS 104-693
MS 104-697

21,0 cm / 8 1/4"
26,0 cm / 10 1/4"



KELLY

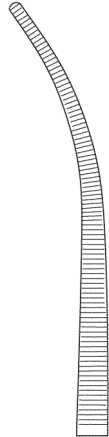

MS 104-700
MS 104-701
MS 104-702



MS 104-708
MS 104-709
MS 104-710



MS 104-715
MS 104-716
MS 104-717

19,0 cm / 7 1/2"
22,0 cm / 8 3/4"
24,0 cm / 9 1/2"



ZENKER

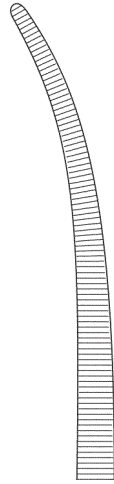

MS 104-730
29,5 cm / 11 5/8"

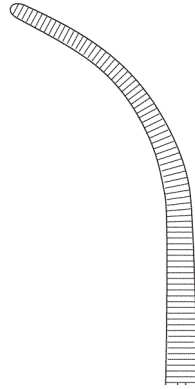

MS 104-731
29,5 cm / 11 5/8"

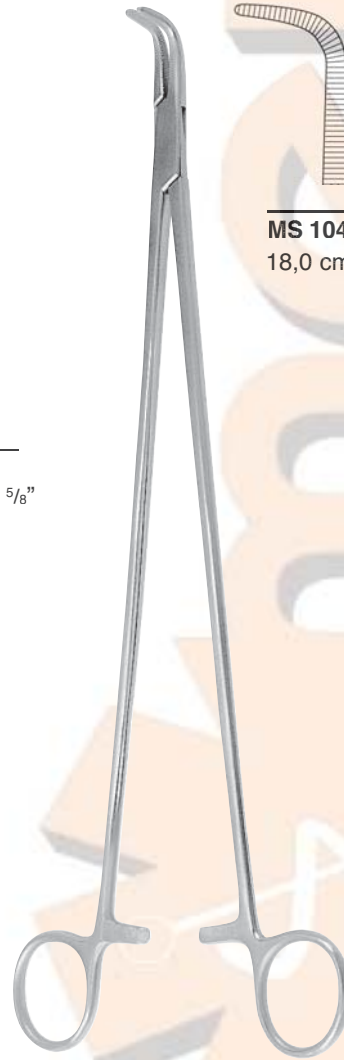

MEEKER



MS 104-740
18,0 cm / 7"

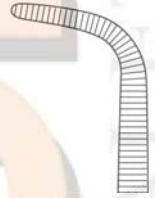

MS 104-741
27,5 cm / 10 3/4"



LAWRENCE

MS 104-750 27,5 cm / 10³/₄"



KANTROWITZ

MS 104-760 19,0 cm / 7¹/₂"
MS 104-761 24,0 cm / 9¹/₂"
MS 104-762 26,5 cm / 10¹/₂"

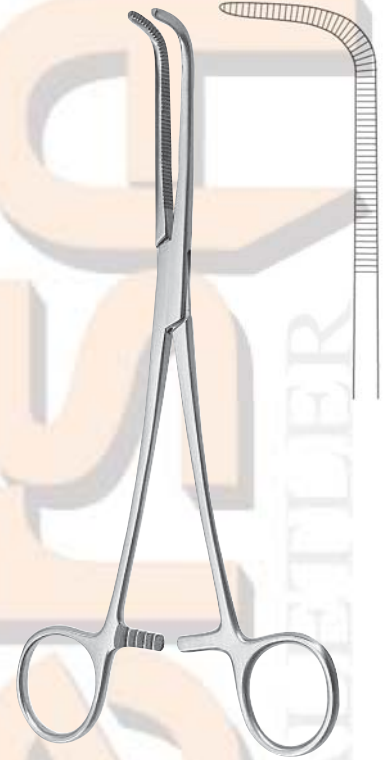

WIRKSTROEM

MS 104-770 21,0 cm / 8¹/₄"
MS 104-771 24,0 cm / 9¹/₂"

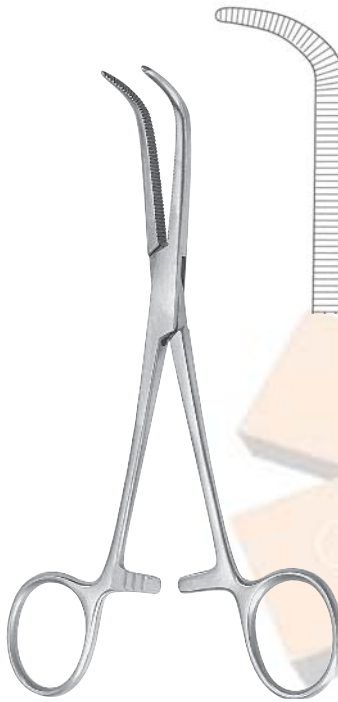

MIXTER

MS 104-780 14,5 cm / 5³/₄"
MS 104-781 15,5 cm / 6¹/₈"
MS 104-782 19,0 cm / 7¹/₂"

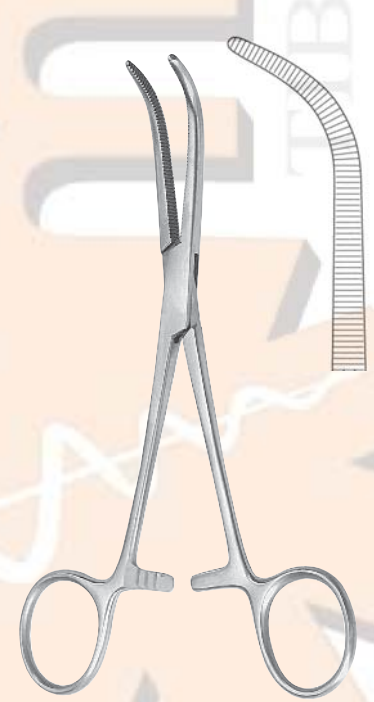

MIXTER-O`SHAUGNESSY

MS 104-783 15,5 cm / 6¹/₈"
MS 104-784 19,0 cm / 7¹/₂"

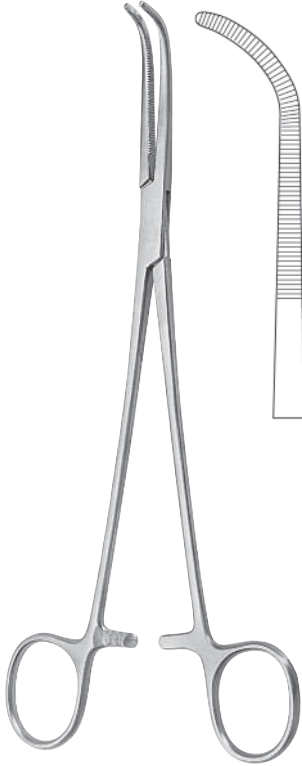

MIXTER
MS 104-785 22,0 cm / 8³/₄"



MIXTER
MS 104-786 23,0 cm / 9"

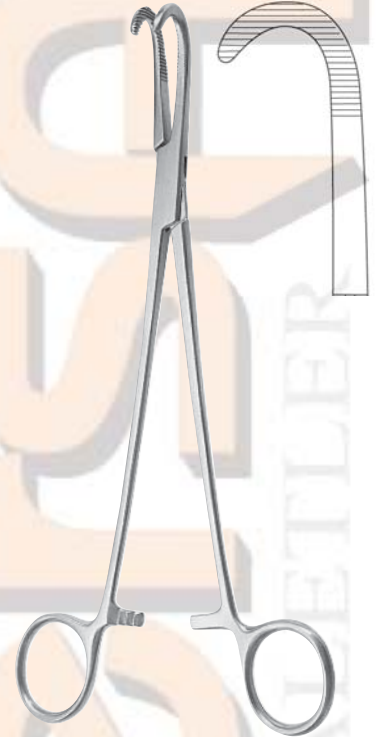

DESJARDINS
MS 104-790 21,0 cm / 8¹/₄"



NEGUS

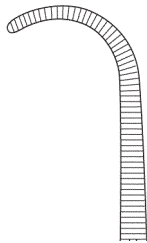

MS 104-800
19,0 cm / 7¹/₂"

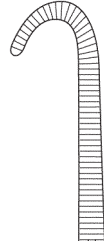

MS 104-801
19,0 cm / 7¹/₂"

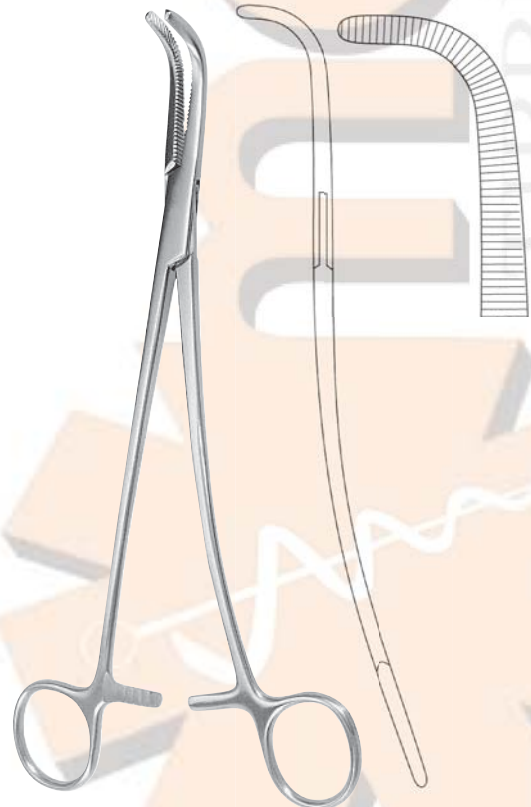

GRAY

MS 104-805 22,0 cm / 8³/₄"
MS 104-806 23,0 cm / 9"



MIXTER

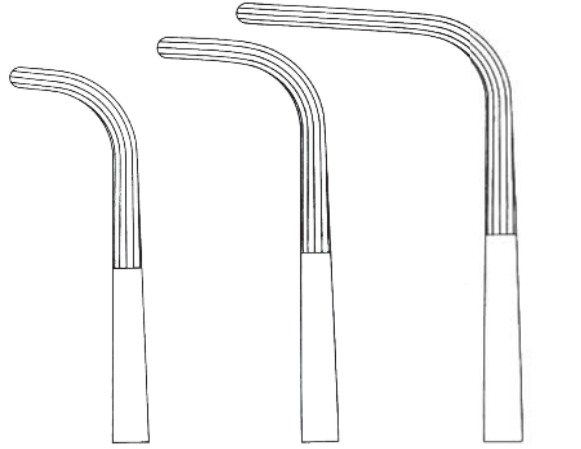

MS 104-820
22,0 cm / 8³/₄"

MS 104-821
25,0 cm / 9³/₄"

MS 104-822
28,0 cm / 11"



LOWER

MS 104-830 18,0 cm / 7"

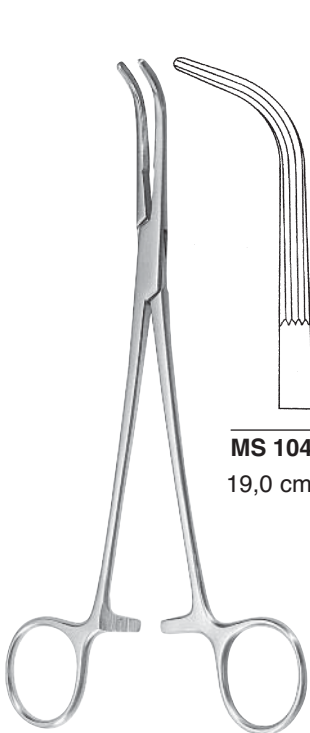

LAHEY

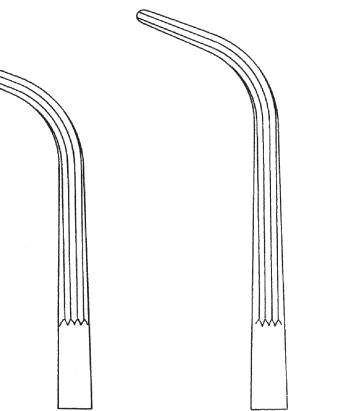

MS 104-831
19,0 cm / 7¹/₂"

MS 104-832
23,0 cm / 9"



FINOCCHIETTO

MS 104-833 24,0 cm / 9¹/₂"



MC QUIGG-MIXTER

MS 104-834 22,0 cm / 8³/₄"



GUYON
MS 104-850 23,0 cm / 12 1/2"



GUYON-ATRAUMA

MS 104-851
23,0 cm / 9"

MS 104-852
24,0 cm / 9 1/2"

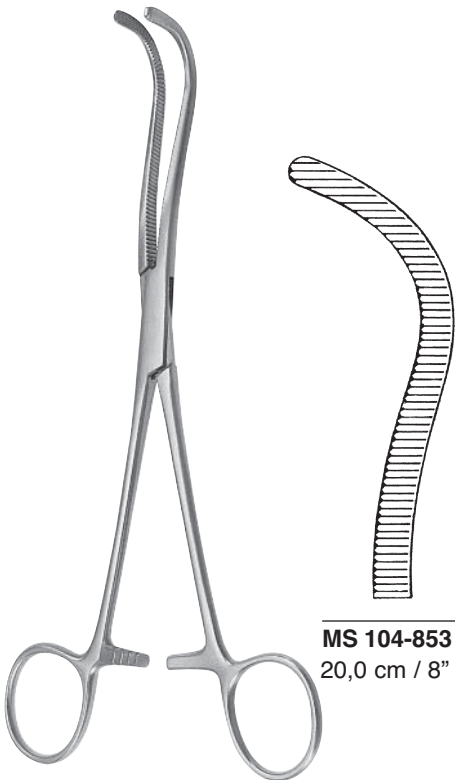

MS 104-853
20,0 cm / 8"

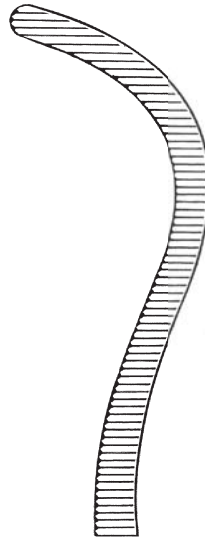

MS 104-854
22,0 cm / 8 3/4"

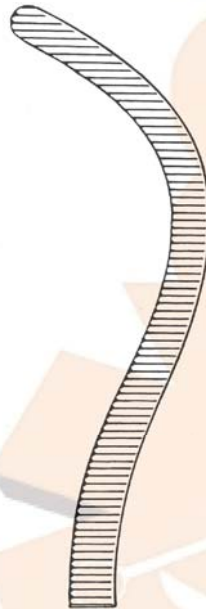

MS 104-855
24,0 cm / 9 1/2"

GUYON

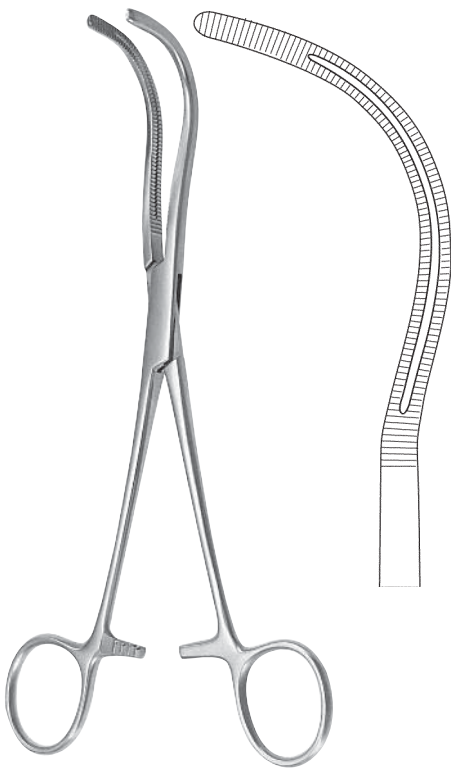

STILLE
MS 104-860 23,0 cm / 9"

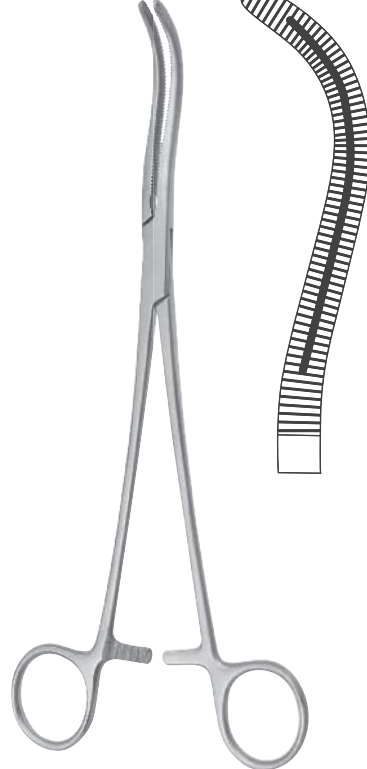

STILLE
MS 104-865 23,0 cm / 9"

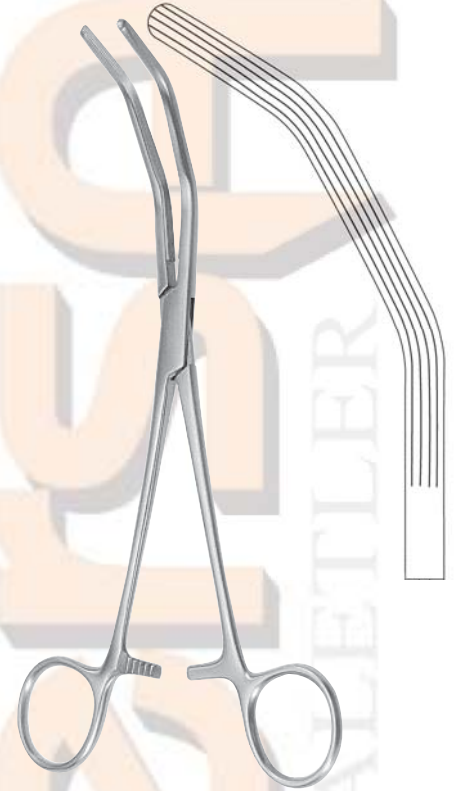

HERRICK
MS 104-867 23,0 cm / 9"

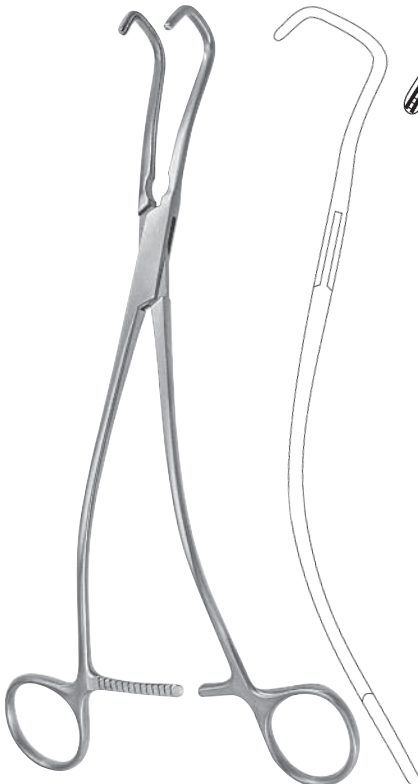

URO-TANGENTIAL

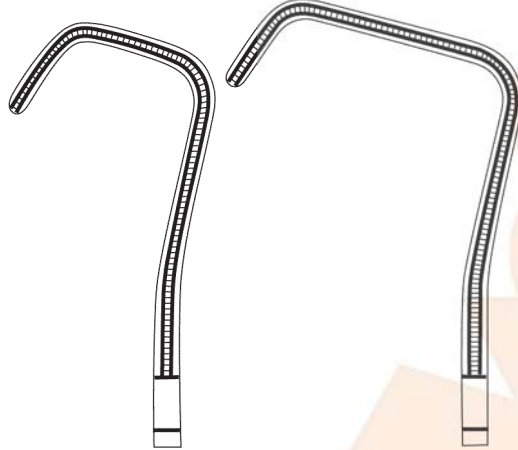

MS 104-868
23,0 cm / 9"

MS 104-869
24,0 cm / 9 1/2"

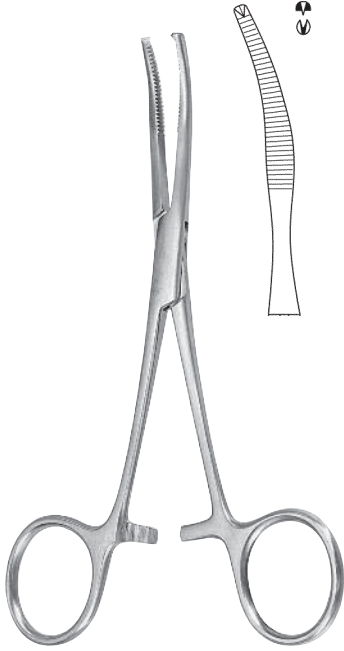

BABY-MIKULICZ
MS 104-880 14,0 cm / 5³/₄"



MIKULICZ
MS 104-881 18,0 cm / 7"
MS 104-882 20,0 cm / 8"

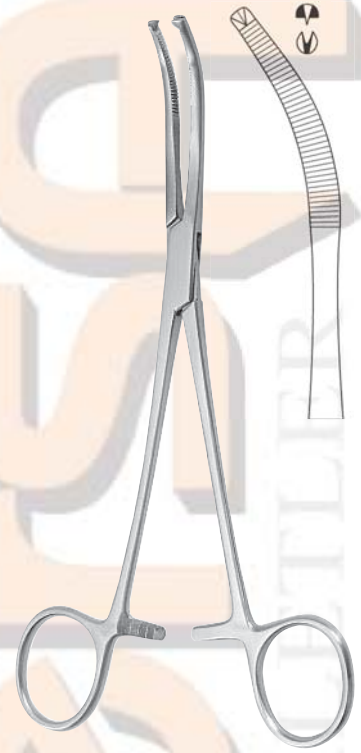

MIKULICZ
MS 104-883 18,0 cm / 7"
MS 104-884 20,0 cm / 8"

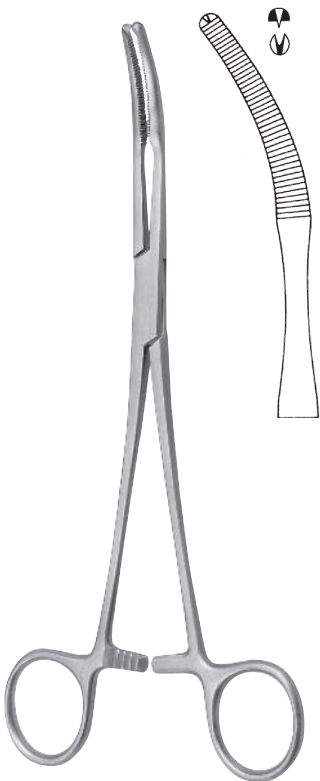

MIKULICZ
MS 104-885 20,0 cm / 8"



MIKULICZ
MS 104-886 20,5 cm / 8"

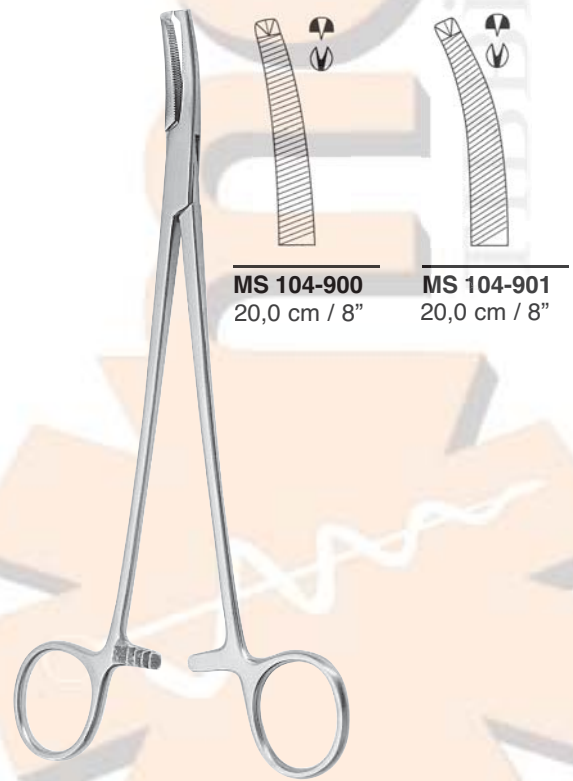

FAURE

MS 104-900 20,0 cm / 8"
MS 104-901 20,0 cm / 8"

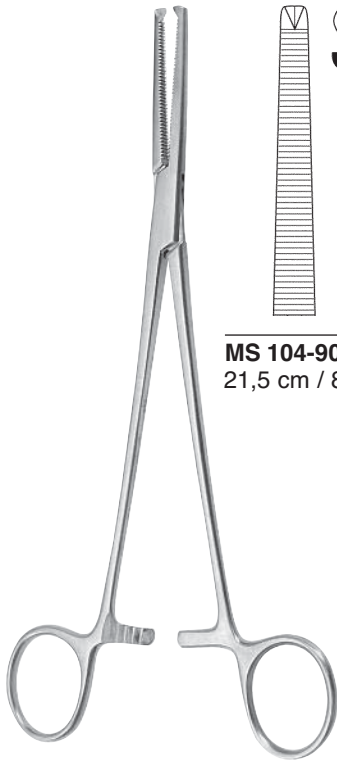

MS 104-902
21,5 cm / 8 1/2"

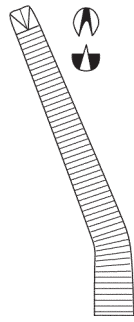

MS 104-903
21,5 cm / 8 1/2"

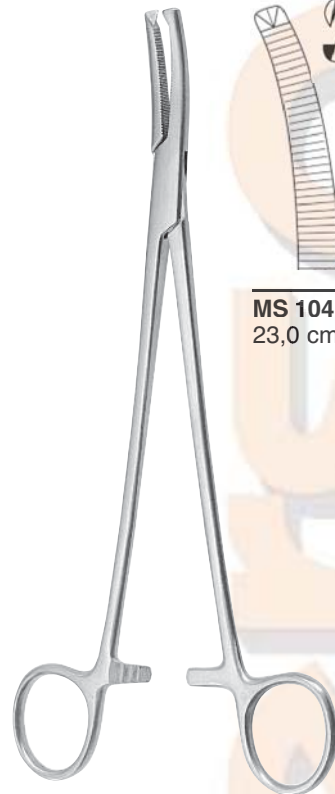

MS 104-904
23,0 cm / 9"

MS 104-905
23,0 cm / 9"



PHANEUF

WERTHEIM

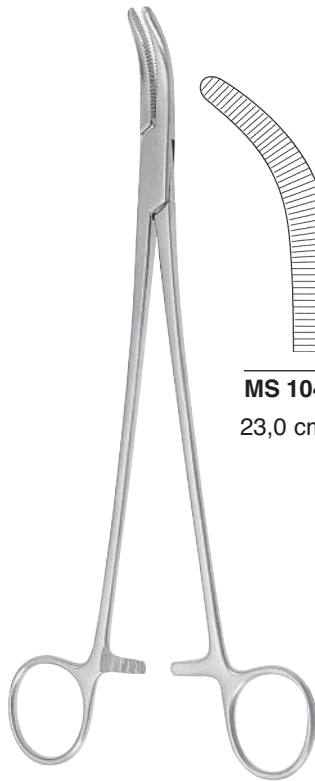

MS 104-906
23,0 cm / 9"

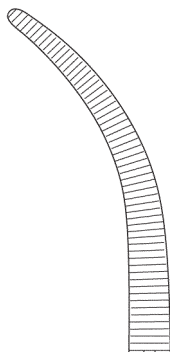

MS 104-907
24,0 cm / 9 1/2"

MOYNIHAN



WERTHEIM
MS 104-920 25,0 cm / 10"



WERTHEIM-CULLEN
MS 104-921 21,5 cm / 8 1/2"



WERTHEIM
MS 104-922 24,0 cm / 9 1/2"



WERTHEIM
MS 104-923 23,5 cm / 9 1/4"



WERTHEIM
MS 104-924 23,5 cm / 9 1/4"

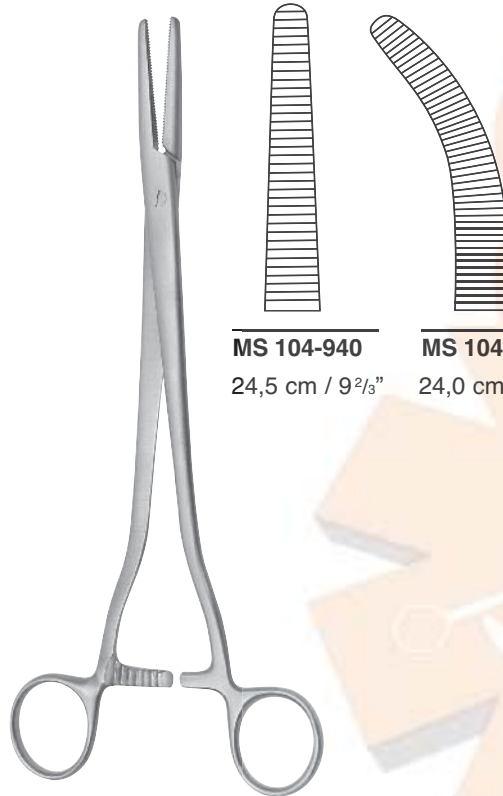

SEGOND-LANDAU

MS 104-940
24,5 cm / 9 2/3"

MS 104-941
24,0 cm / 9 1/2"

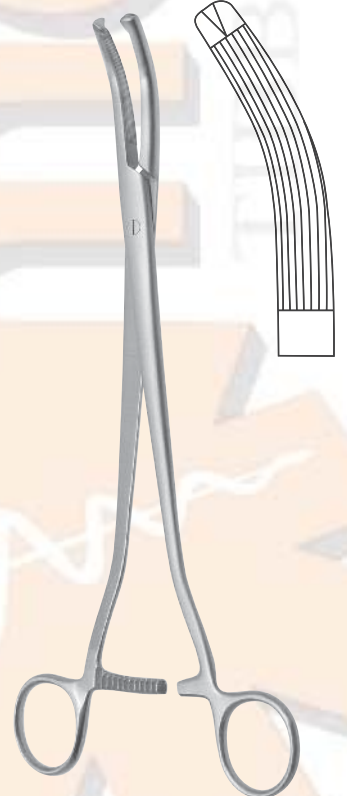

MIKULICZ
MS 104-942 24,5 cm / 9 2/3"

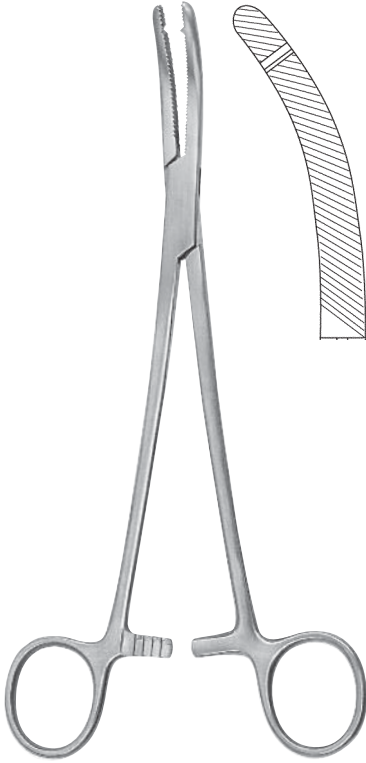

HEANEY

- MS 104-950 19,5 cm / 7³/₄"
- MS 104-951 21,0 cm / 8¹/₄"
- MS 104-952 23,0 cm / 9"

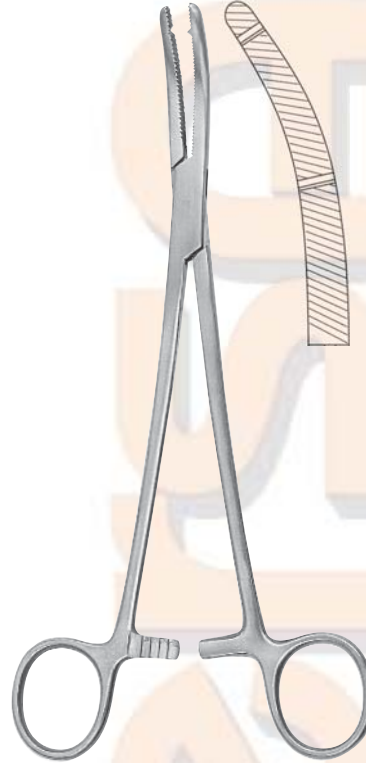

HEANEY

- MS 104-953 19,5 cm / 7³/₄"
- MS 104-954 21,0 cm / 8¹/₄"
- MS 104-955 23,0 cm / 9"

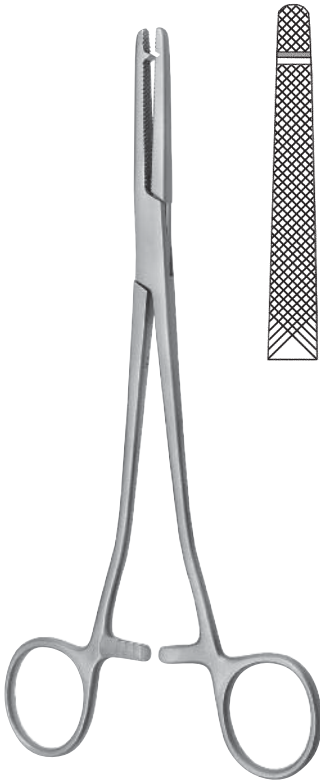

HEANEY-REZEK

- MS 104-970 21,0 cm / 8¹/₄"

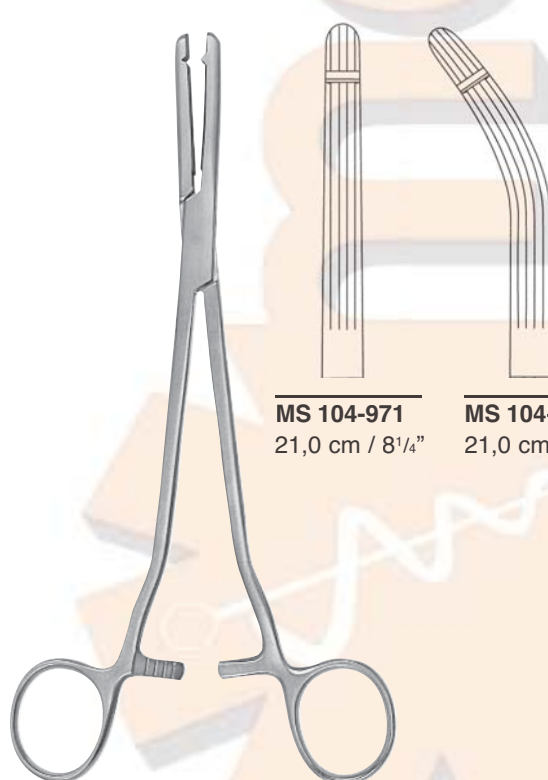

HEANEY-BALLENTINE

- MS 104-971 21,0 cm / 8¹/₄"
- MS 104-972 21,0 cm / 8¹/₄"

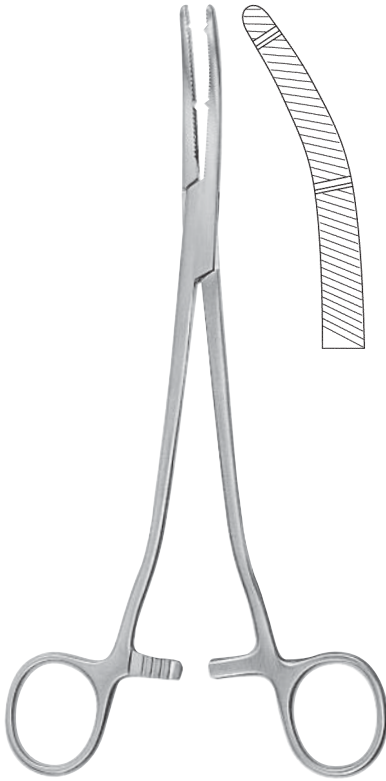

HEANEY-KANTER

MS 104-973 21,0 cm / 8 1/4"

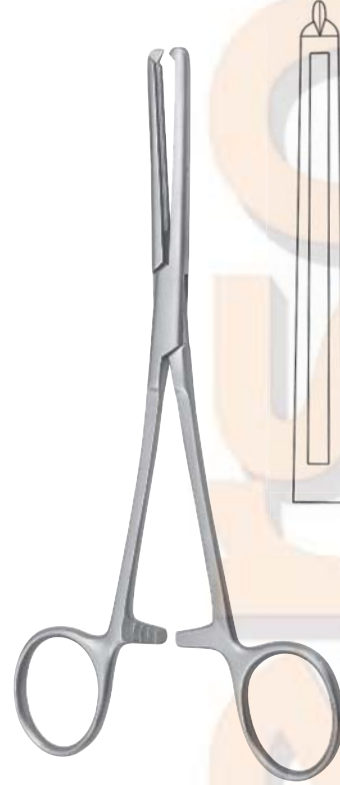

MAINGOT

MS 104-974 20,0 cm / 8"

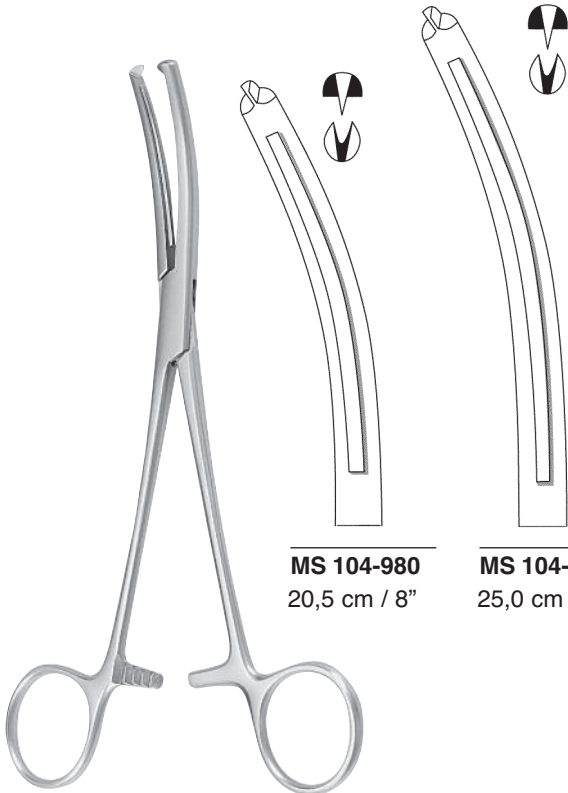

MS 104-980
20,5 cm / 8"

MS 104-981
25,0 cm / 10"

MAINGOT

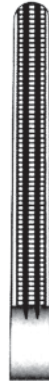

MS 104-990
21,5 cm / 8 1/2"



MS 104-991
21,0 cm / 8 1/4"



MS 104-992
20,5 cm / 8"



MS 104-993
20,0 cm / 8"



MS 104-994
25,0 cm / 9 3/4"



MS 104-995
25,0 cm / 9 3/4"

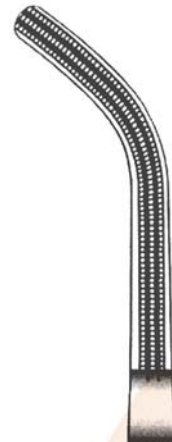

MS 104-996
24,5 cm / 9 2/3"



MS 104-997
23,0 cm / 9 1/4"



SCHAEDEL

MS 104-1010 9,0 cm / 3¹/₂"



ENGL. MODELL

MS 104-1011 9,0 cm / 3¹/₂"



JONES

MS 104-1012 5,0 cm / 2"

MS 104-1013 9,0 cm / 3¹/₂"



JONES-FRIMED

MS 104-1014 9,0 cm / 3¹/₂"



BACKHAUS

MS 104-1030 8,0 cm / 3¹/₈"

MS 104-1031 11,0 cm / 4³/₈"

MS 104-1032 13,0 cm / 5¹/₈"

MS 104-1033 15,0 cm / 6"



MS 104-1033 11,0 cm / 4³/₈"



ROEDER

MS 104-1040 13,0 cm / 5 1/8"
MS 104-1041 15,0 cm / 6"



LORNA

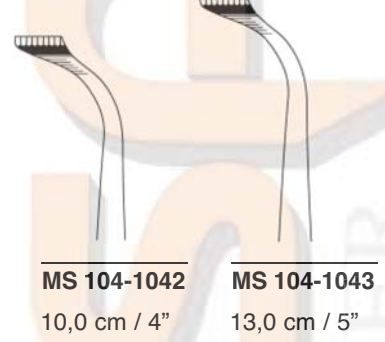

MS 104-1042
 10,0 cm / 4"

MS 104-1043
 13,0 cm / 5"



BERNHARD

MS 104-1044 16,5 cm / 6 1/2"



LANE

MS 104-1045 15,0 cm / 6"
MS 104-1046 18,0 cm / 7"
MS 104-1047 20,0 cm / 8"

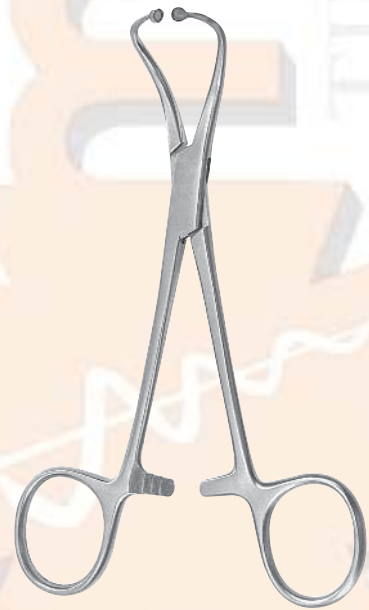

BALL + SOCKET

MS 104-1048 11,5 cm / 4 1/2"
MS 104-1049 13,0 cm / 5 1/3"

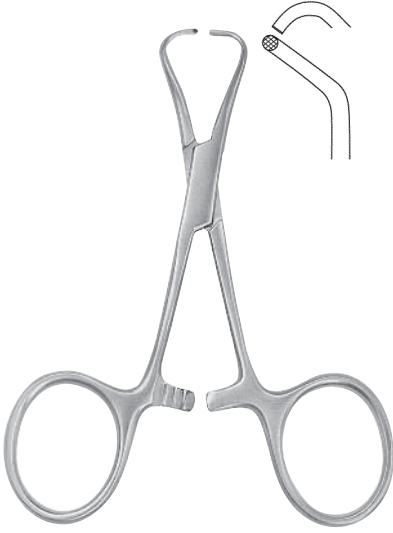

TOHOKU

MS 104-1050 10,0 cm / 4"
MS 104-1051 13,0 cm / 5 1/8"



PEERS-BERTRAM

MS 104-1052 14,5 cm / 5 3/4"



MS 104-1053 10,0 cm / 4"
MS 104-1054 13,0 cm / 5 1/8"



HOFF

MS 104-1055 11,0 cm / 4 3/8"
MS 104-1056 14,5 cm / 5 3/4"



ROBIN

MS 104-1057 13,5 cm / 5 1/4"

Ø 5 mm kabloları kadar
for cables up to Ø 5 mm



ROBIN

MS 104-1058 13,5 cm / 5 1/4"

Ø 13 mm kabloları kadar
for cables up to Ø 13 mm

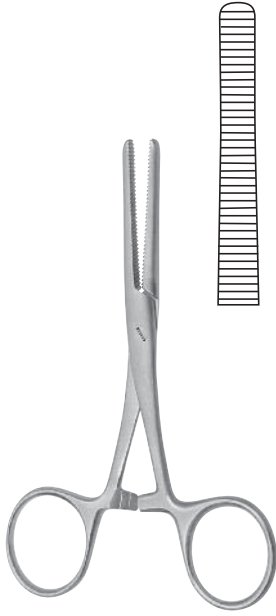

PEAN

MS 104-1070 12,5 cm / 5"

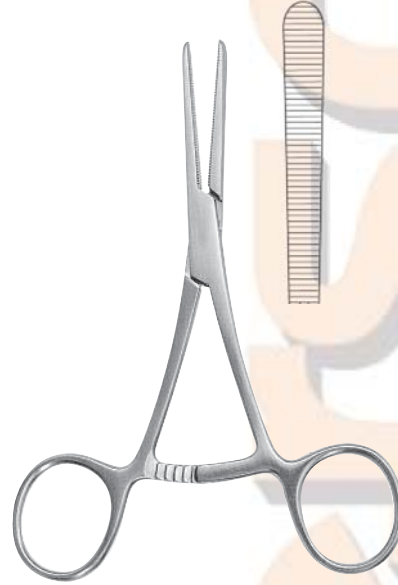

BERLIN

MS 104-1071 14,5 cm / 5³/₄"



PRESBYTERIAN

MS 104-1072 16,0 cm / 6¹/₄"

MS 104-1073 18,0 cm / 7"

MS 104-1074 20,0 cm / 8"

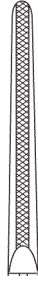

MS 104-1075
15,5 cm / 6 1/8"

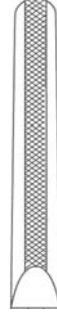

MS 104-1076
18,0 cm / 7"



MS 104-1077
20,0 cm / 8"



MS 104-1078
15,5 cm / 6 1/8"

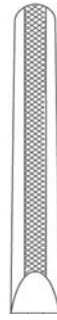

MS 104-1079
18,0 cm / 7"



MS 104-1080
20,0 cm / 8"



GROSS-MAIER

MS 104-1090
MS 104-1091

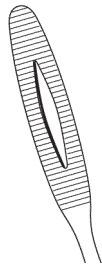

MS 104-1092 20,0 cm / 8"
MS 104-1093 26,5 cm / 10 1/2"

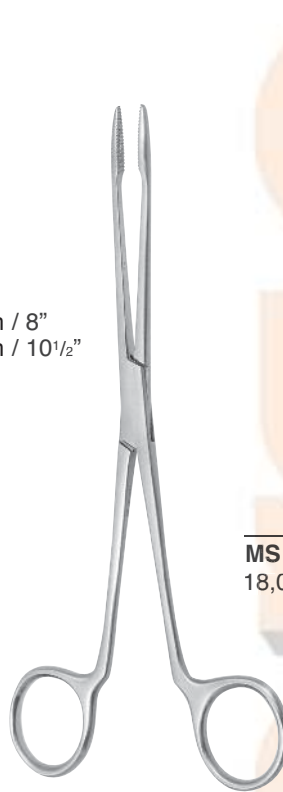

GROSS

MS 104-1094
18,0 cm / 7"



MS 104-1095
18,0 cm / 7"



GROSS

MS 104-1096
18,0 cm / 7"



MS 104-1097
18,0 cm / 7"

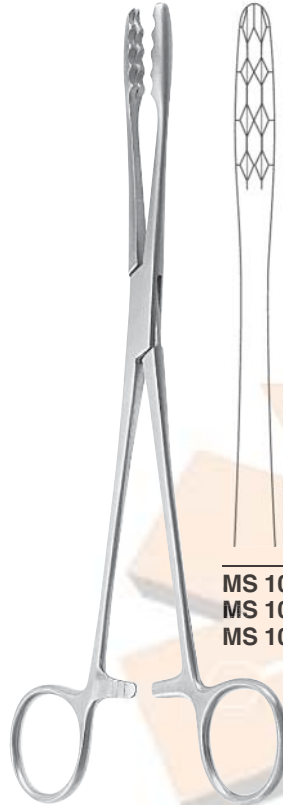

ULRICH

MS 104-1110
MS 104-1111
MS 104-1112

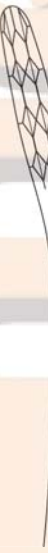

MS 104-1113 22,0 cm / 8 3/4"
MS 104-1114 25,0 cm / 9 3/4"
MS 104-1115 27,0 cm / 10 3/4"

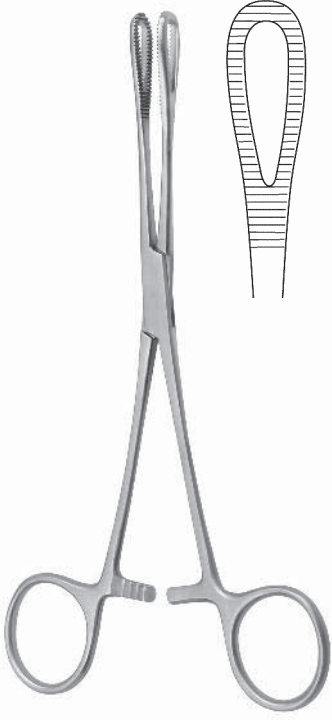

RAMPLEY

MS 104-1130 18,0 cm / 7"
MS 104-1131 25,0 cm / 9³/₄"



LISTER

MS 104-1140 13,0 cm / 5¹/₈"
MS 104-1141 16,0 cm / 6¹/₄"
MS 104-1142 18,0 cm / 7"



BRYANT

MS 104-1150 13,0 cm / 5¹/₈"

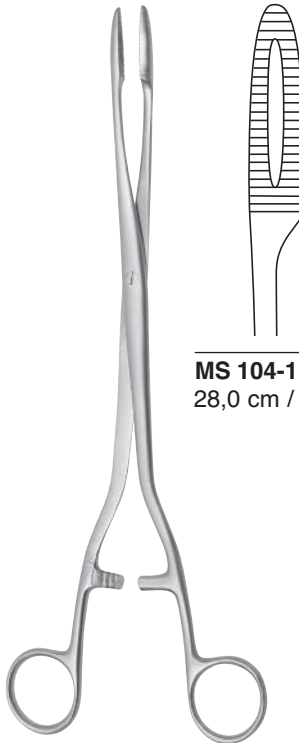

SIMS-MAIER

MS 104-1151
28,0 cm / 11"

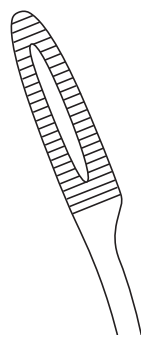

MS 104-1152
28,0 cm / 11"



COLLIN

MS 104-1153 25,0 cm / 9³/₄"



CHERON

MS 104-1154 25,0 cm / 9³/₄"

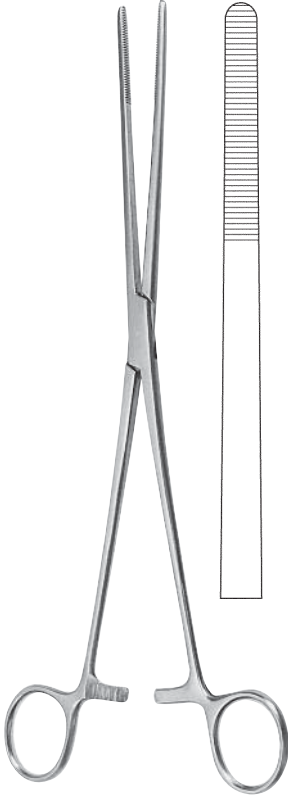

BOZEMANN
MS 104-1160 26,0 cm / 10¹/₄"



BOZEMANN
MS 104-1161 26,0 cm / 10¹/₄"



BOZEMANN-DOUGLAS
MS 104-1162 26,0 cm / 10¹/₄"



FOERSTER

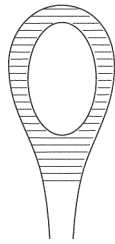

MS 104-1180
MS 104-1181
MS 104-1182

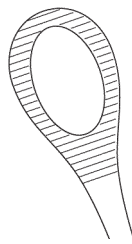

MS 104-1183
MS 104-1184
MS 104-1185



MS 104-1186
MS 104-1187
MS 104-1188



MS 104-1189 18,0 cm / 7"
MS 104-1190 20,0 cm / 8"
MS 104-1191 25,0 cm / 9³/₄"



FOERSTER

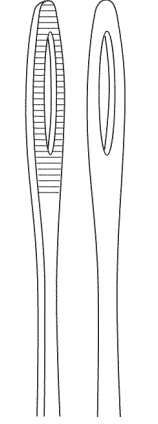

MS 104-1192
25,0 cm / 9³/₄"

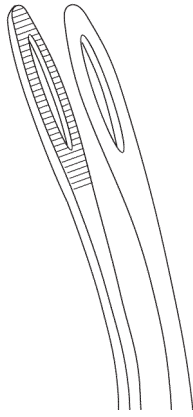

MS 104-1193
25,0 cm / 9³/₄"

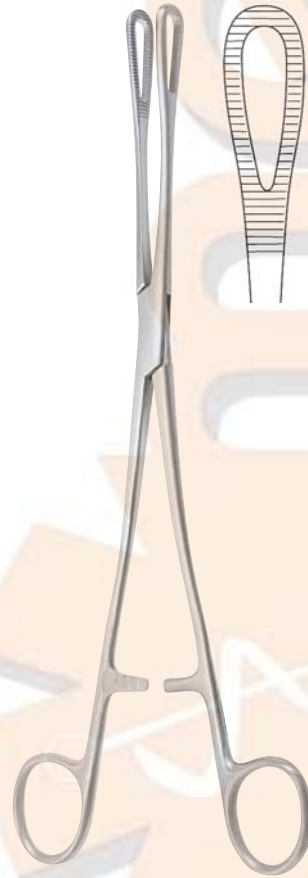

RAMPLEY
MS 104-1200 25,0 cm / 9³/₄"



TITANIUM VENA

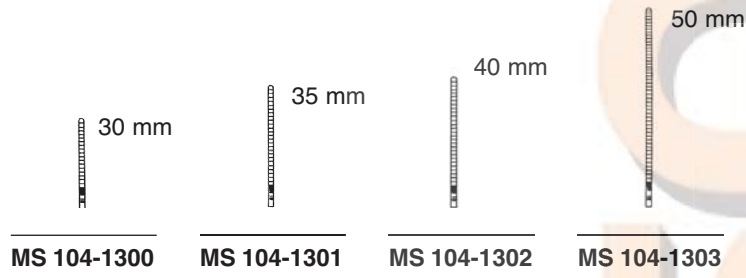

TITANIUM VENA

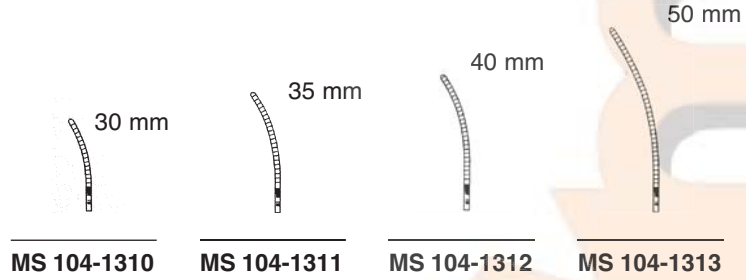



TITANIUM ARTERIA

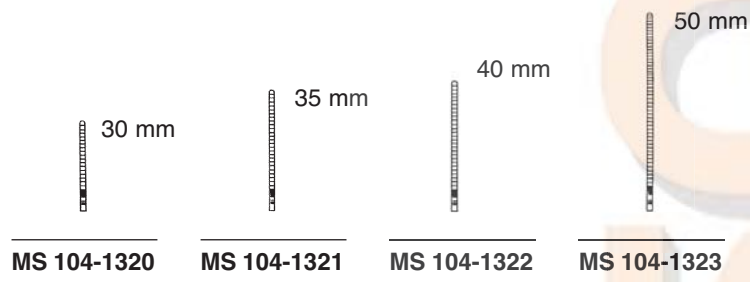

TITANIUM ARTERIA

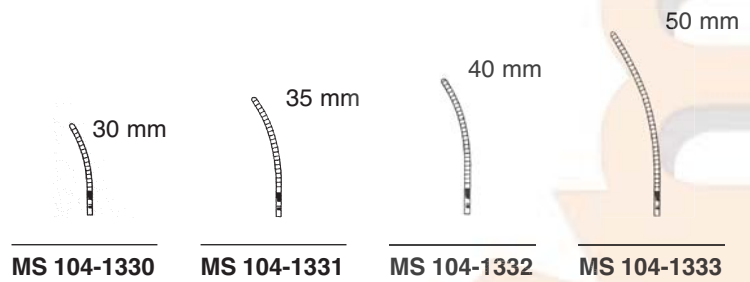



MS 104-1340
MS 104-1350
30 mm



MS 104-1341
MS 104-1351
35 mm



MS 104-1342
MS 104-1352
40 mm



MS 104-1343
MS 104-1353
50 mm



TITANIUM VENA
MS 104-1340 / MS 104-1343

TITANIUM ARTERIA
MS 104-1350 / MS 104-1353



MS 104-1360 24,0 cm / 9 1/2"



DIETRICH



MS 104-1370
8 mm (L)



MS 104-1371
12 mm (L)

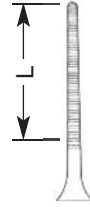

MS 104-1372
20 mm (L)



MS 104-1373
8 mm (L)



MS 104-1374
12 mm (L)



MS 104-1375
20 mm (L)



DEBAKEY-DIETRICH



MS 104-1390
10 mm (L)



MS 104-1391
14 mm (L)

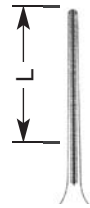

MS 104-1392
20 mm (L)



MS 104-1393
10 mm (L)



MS 104-1394
14 mm (L)



MS 104-1395
20 mm (L)



MS 104-1410
3,5 cm / 1 1/2"



MS 104-1411
5,0 cm / 2"

DIEFENBACH



MS 104-1412
3,5 cm / 1 1/2"



MS 104-1413
5,0 cm / 2"

DIEFENBACH

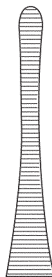

JOHNS-HOPKINS

- MS 104-1420** 5,0 cm / 2"
- MS 104-1421** 6,5 cm / 2 1/2"
- MS 104-1422** 7,5 cm / 3"



JOHNS-HOPKINS

- MS 104-1423** 5,0 cm / 2"
- MS 104-1424** 6,5 cm / 2 1/2"
- MS 104-1425** 7,5 cm / 3"

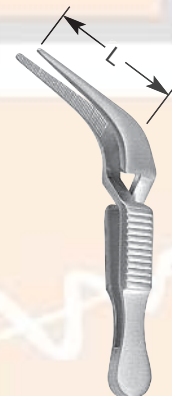

HESS L

- MS 104-1440** 20 mm
- MS 104-1441** 30 mm