



103



PENSETLER
FORCEPS



STANDART

MS 103-101	10,5 cm / 4 1/8"
MS 103-102	11,5 cm / 4 1/2"
MS 103-103	13,0 cm / 5"
MS 103-104	14,5 cm / 5 3/4"
MS 103-105	16,0 cm / 6 1/4"
MS 103-106	18,0 cm / 7"
MS 103-107	20,0 cm / 8"
MS 103-108	25,0 cm / 10"
MS 103-109	30,0 cm / 12"



STANDART

MS 103-120	11,5 cm / 4 1/2"
MS 103-121	13,0 cm / 5"
MS 103-122	14,5 cm / 5 3/4"
MS 103-123	16,0 cm / 6 1/4"
MS 103-124	18,0 cm / 7"
MS 103-125	20,0 cm / 8"
MS 103-126	25,0 cm / 10"
MS 103-127	30,0 cm / 12"



MOD. USA

MS 103-140	12,0 cm / 4 3/4"
MS 103-141	13,0 cm / 5"
MS 103-142	14,5 cm / 5 3/4"
MS 103-143	15,5 cm / 6"
MS 103-144	18,0 cm / 7"
MS 103-145	21,0 cm / 8"
MS 103-146	25,0 cm / 10"
MS 103-147	31,0 cm / 12"



MOD. USA

MS 103-160	12,0 cm / 4 3/4"
MS 103-161	13,0 cm / 5"
MS 103-162	14,5 cm / 5 3/4"
MS 103-163	15,5 cm / 6 1/8"



ADSON

MS 103-170	12,0 cm / 4 3/4"
MS 103-171	15,0 cm / 6"



MICRO-ADSON

MS 103-172	12,0 cm / 4 3/4"
MS 103-173	15,0 cm / 6"



MC INDOE

MS 103-180 15,0 cm / 6"



SEMKEN

MS 103-181 12,5 cm / 5"
MS 103-182 15,0 cm / 6"



POTTS-SMITH

MS 103-183 18,0 cm / 7"
MS 103-184 21,0 cm / 8 1/4"
MS 103-185 25,0 cm / 10"

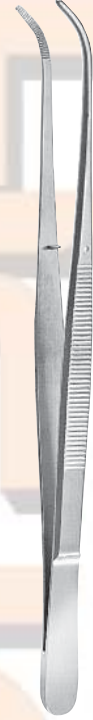

POTTS-SMITH

MS 103-186 18,0 cm / 7"
MS 103-187 21,0 cm / 8 1/4"
MS 103-188 25,0 cm / 10"



BROPHY

MS 103-189 20,0 cm / 8"



BROPHY

MS 103-190 20,0 cm / 8"



TAYLOR

MS 103-191 17,5 cm / 7"



TAYLOR

MS 103-192 17,5 cm / 7"



CUSHING

MS 103-193 17,5 cm / 7"



CUSHING

MS 103-194 17,5 cm / 7"



GERALD

MS 103-195 18,0 cm / 7"



GERALD

MS 103-196 18,0 cm / 7"



MS 103-210 12,5 cm / 5"
MS 103-211 15,5 cm / 6 1/8"



DUEHRSEN

MS 103-212 20,0 cm / 8"



RAMSEY

MS 103-213 18,0 cm / 7"



STANDART

MS 103-230	10,5 cm / 4 1/8"
MS 103-231	11,5 cm / 4 1/2"
MS 103-232	13,0 cm / 5"
MS 103-233	14,5 cm / 5 3/4"
MS 103-234	16,0 cm / 6 1/4"
MS 103-235	18,0 cm / 7"
MS 103-236	20,0 cm / 8"
MS 103-237	25,0 cm / 10"
MS 103-238	30,0 cm / 12"



MS 103-250	11,5 cm / 4 1/2"
MS 103-251	13,0 cm / 5"
MS 103-252	14,5 cm / 5 3/4"
MS 103-253	16,0 cm / 6 1/4"
MS 103-254	18,0 cm / 7"
MS 103-255	20,0 cm / 8"
MS 103-256	25,0 cm / 10"
MS 103-257	30,0 cm / 12"



MS 103-270	13,0 cm / 5"
MS 103-271	14,5 cm / 5 3/4"
MS 103-272	16,0 cm / 6 1/4"



MS 103-273	13,0 cm / 5"
MS 103-274	14,5 cm / 5 3/4"
MS 103-275	16,0 cm / 6 1/4"



MS 103-290	11,5 cm / 4 1/2"
MS 103-291	13,0 cm / 5"
MS 103-292	14,5 cm / 5 3/4"
MS 103-293	16,0 cm / 6 1/4"
MS 103-294	18,0 cm / 7"
MS 103-295	20,0 cm / 8"



MS 103-310	13,0 cm / 5"
MS 103-311	14,5 cm / 5 3/4"



USA MODELL

- MS 103-312 12,0 cm / 4³/₄"
- MS 103-313 13,0 cm / 5"
- MS 103-314 14,5 cm / 5³/₄"
- MS 103-315 15,5 cm / 6"
- MS 103-316 18,0 cm / 7"
- MS 103-317 21,0 cm / 8¹/₄"
- MS 103-318 25,0 cm / 9³/₄"
- MS 103-319 31,0 cm / 12¹/₄"



USA MODELL

- MS 103-330 13,0 cm / 5"
- MS 103-331 14,5 cm / 5³/₄"
- MS 103-332 15,5 cm / 6"



STILLE

- MS 103-340 15,0 cm / 6"



STILLE

- MS 103-341 15,0 cm / 6"



ADSON

- MS 103-350 12,0 cm / 4³/₄"
- MS 103-351 15,0 cm / 6"



MIKRO-ADSON

- MS 103-352 12,0 cm / 4³/₄"
- MS 103-353 15,0 cm / 6"



ADSON

- MS 103-354 12,0 cm / 4³/₄"

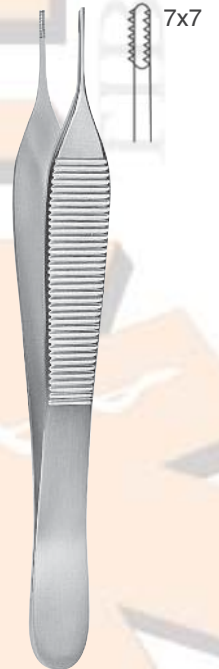

ADSON-BROWN

- MS 103-355 12,0 cm / 4³/₄"



STONE
MS 103-360 15,0 cm / 6"



LERCHE
MS 103-361 15,0 cm / 6"



ADLERKREUTZ
MS 103-370 15,0 cm / 6"
MS 103-371 20,0 cm / 8"



ADLERKREUTZ
MS 103-372 15,0 cm / 6"
MS 103-373 20,0 cm / 8"



GILLIES
MS 103-380 15,0 cm / 6"



SEMKEN
MS 103-381 12,5 cm / 5"
MS 103-382 15,0 cm / 6"



TAYLOR
MS 103-383 17,5 cm / 7"



TAYLOR
MS 103-384 17,5 cm / 7"



GERALD
MS 103-385 17,5 cm / 7"



GERALD
MS 103-386 17,5 cm / 7"



CUSHING
MS 103-387 17,5 cm / 7"



CUSHING
MS 103-388 17,5 cm / 7"



POTTS-SMITH
MS 103-389 18,0 cm / 7"
MS 103-390 21,0 cm / 8¼"
MS 103-391 25,0 cm / 10"



POTTS-SMITH
MS 103-392 18,0 cm / 7"
MS 103-393 21,0 cm / 8¼"
MS 103-394 25,0 cm / 10"



BROPHY
MS 103-395 20,0 cm / 8"



BROPHY
MS 103-396 20,0 cm / 8"



WAUGH
MS 103-410 20,0 cm / 8"



DUEHRSEN
MS 103-411 20,0 cm / 8"



STILLE-BARRAYA
MS 103-412 18,0 cm / 7"
MS 103-413 20,0 cm / 8"
MS 103-414 25,0 cm / 10"



FERRIS-SMITH

MS 103-420
18,0 cm / 7"

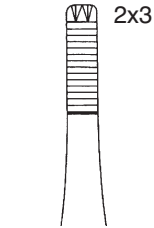

MS 103-421
18,0 cm / 7"



LANE
MS 103-430 14,5 cm / 5³/₄"
MS 103-431 17,5 cm / 7"



LANE
MS 103-432 14,5 cm / 5³/₄"
MS 103-433 17,5 cm / 7"



RAMSEY
MS 103-440 18,0 cm / 7"



RAMSEY
MS 103-441 18,0 cm / 7"



BONNEY
MS 103-450 18,0 cm / 7"

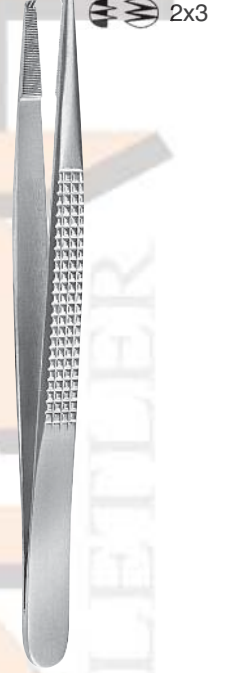

BONNEY
MS 103-451 18,0 cm / 7"



TREVES
MS 103-460 13,0 cm / 5"
MS 103-461 15,0 cm / 6"



BROWN
MS 103-470 15,0 cm / 6"



DURANTE
MS 103-480 14,5 cm / 5³/₄"
MS 103-481 16,0 cm / 6¹/₄"
MS 103-482 20,0 cm / 8"



RUSS. MODELL
MS 103-490 15,0 cm / 6"
MS 103-491 20,0 cm / 8"
MS 103-492 25,0 cm / 10"



NELSON
MS 103-500 23,0 cm / 9"



DUVAL
MS 103-501 14,0 cm / 5 1/2"



COLLIN-DUVAL



FIG. 1
MS 103-502
20,0 cm / 8"

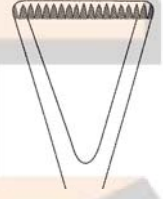

FIG. 2
MS 103-503
20,0 cm / 8"

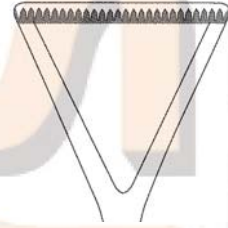

FIG. 3
MS 103-504
20,0 cm / 8"



SINGLEY-TUTTLE
MS 103-505 23,0 cm / 9"



DENIS-BROWNE
MS 103-506 20,0 cm / 8"



GRAEFE
MS 103-521 10,0 cm / 4"



GRAEFE
MS 103-522 10,0 cm / 4"



GRAEFE
MS 103-523 10,0 cm / 4"

↔ 1x2



GRAEFE
MS 103-524 10,0 cm / 4"

↔ 1x2



GRAEFE
MS 103-525 10,0 cm / 4"

↔ 1x2



GRAEFE
MS 103-526 10,0 cm / 4"



MS 103-527 8,0 cm / 3 1/4"
MS 103-528 9,0 cm / 3 1/2"
MS 103-529 10,5 cm / 4 1/8"
MS 103-530 11,5 cm / 4 1/2"
MS 103-531 12,5 cm / 5"



MS 103-532 8,0 cm / 3 1/4"
MS 103-533 9,0 cm / 3 1/2"
MS 103-534 10,5 cm / 4 1/8"
MS 103-535 11,5 cm / 4 1/2"
MS 103-536 12,5 cm / 5"



MS 103-537 8,0 cm / 3 1/4"
MS 103-538 9,0 cm / 3 1/2"
MS 103-539 10,5 cm / 4 1/8"
MS 103-540 11,5 cm / 4 1/2"
MS 103-541 12,5 cm / 5"



MS 103-542 8,0 cm / 3 1/4"
MS 103-543 9,0 cm / 3 1/2"
MS 103-544 10,5 cm / 4 1/8"
MS 103-545 11,5 cm / 4 1/2"
MS 103-546 12,5 cm / 5"



HUNTER
MS 103-560 10,5 cm / 4 1/4"



HUNTER
MS 103-561 10,5 cm / 4 1/4"



WALTER-CARMALT
MS 103-562 10,5 cm / 4 1/4"



WALTER-CARMALT
MS 103-563 10,5 cm / 4 1/4"



MS 103-570 10,0 cm / 4"



MS 103-571 10,0 cm / 4"



MS 103-572 10,0 cm / 4"



FEILCHENFELD

MS 103-580 7,5 cm / 3 1/8"

MS 103-581 9,0 cm / 3 1/2"

MS 103-582 11,5 cm / 4 1/2"



SHAAF

MS 103-590 9,0 cm / 3 1/2"



LITTAUER

MS 103-591 8,5 cm / 3 1/3"



MS 103-592 9,0 cm / 3 1/2"



DOUGLAS

MS 103-593 9,0 cm / 3 1/2"



DOUGLAS
MS 103-594 9,0 cm / 3 1/2"



BEER
MS 103-595 9,0 cm / 3 1/2"



BARRAQUER
MS 103-596 10,5 cm / 4 1/4"



FIG. 3
MS 103-600 11,5 cm / 4 3/4"



FIG. 4
MS 103-601 11,0 cm / 4 3/8"



FIG. 5
MS 103-602 11,0 cm / 4 3/8"



FIG. 7
MS 103-603 11,5 cm / 4 3/8"

0,3 mm



MS 103-610 11,0 cm / 4³/₈"

0,3 mm x 90°



MS 103-611 11,0 cm / 4³/₈"

0,3 mm x 45°



MS 103-612 11,0 cm / 4³/₈"

0,3 mm x 45°



MS 103-613 11,0 cm / 4³/₈"

0,3 mm

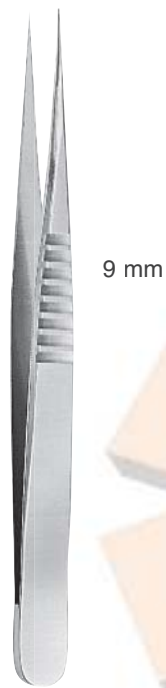

MS 103-614 12,0 cm / 4³/₄"

0,3 mm x 45°

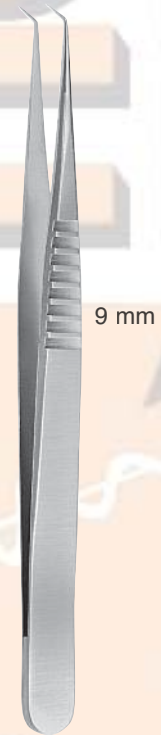

MS 103-615 13,5 cm / 5¹/₄"

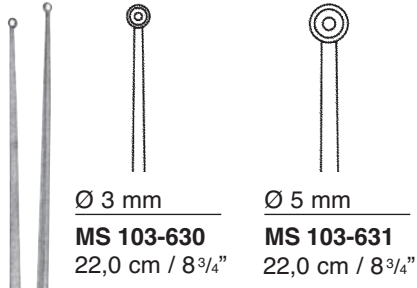

YASARGIL

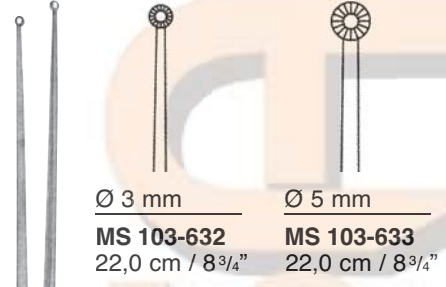

YASARGIL

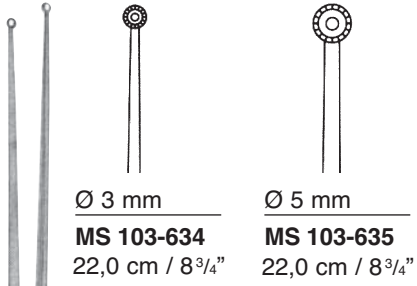

HEIFETZ

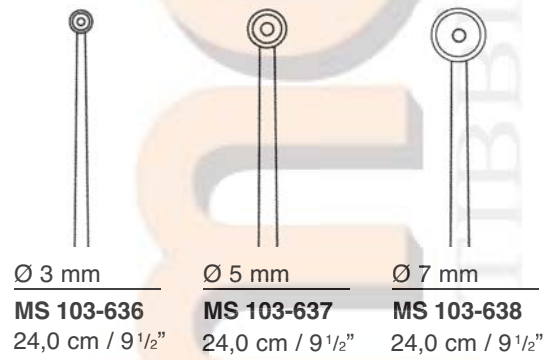

YASARGIL-SAMI



SAMII

MS 103-639 23,0 cm / 9"



SAMII

MS 103-640 23,0 cm / 9"

Ø 5 mm



HUNT

MS 103-641 20,0 cm / 8"

0,6 mm



YASARGIL

MS 103-650 18,0 cm / 7"
MS 103-651 20,0 cm / 8"
MS 103-652 22,0 cm / 8³/₄"
MS 103-653 24,5 cm / 9²/₃"

0,9 mm



YASARGIL

MS 103-654 18,0 cm / 7"
MS 103-655 20,0 cm / 8"
MS 103-656 22,0 cm / 8³/₄"
MS 103-657 24,5 cm / 9³/₄"

1x2



YASARGIL

MS 103-658 18,0 cm / 7"



MS 103-670 15,0 cm / 6"
MS 103-671 18,0 cm / 7"
MS 103-672 21,0 cm / 8¼"



MS 103-673 15,0 cm / 6"
MS 103-674 18,0 cm / 7"
MS 103-675 21,0 cm / 8¼"



MS 103-676 15,0 cm / 6"
MS 103-677 18,0 cm / 7"
MS 103-678 21,0 cm / 8¼"



MS 103-679 15,0 cm / 6"
MS 103-680 18,0 cm / 7"
MS 103-681 21,0 cm / 8¼"



0,3 mm
MS 103-682
 18,5 cm / 7¼"



0,6 mm
MS 103-683
 18,5 cm / 7¼"



0,6 mm
MS 103-684
 18,5 cm / 7¼"

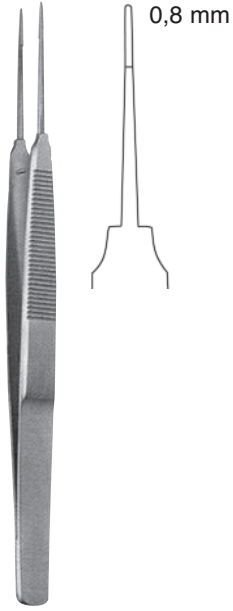

AUSTIN
MS 103-685 14,0 cm / 5 1/2"

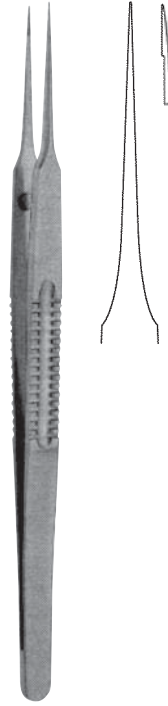

MS 103-686 18,5 cm / 7 1/4"

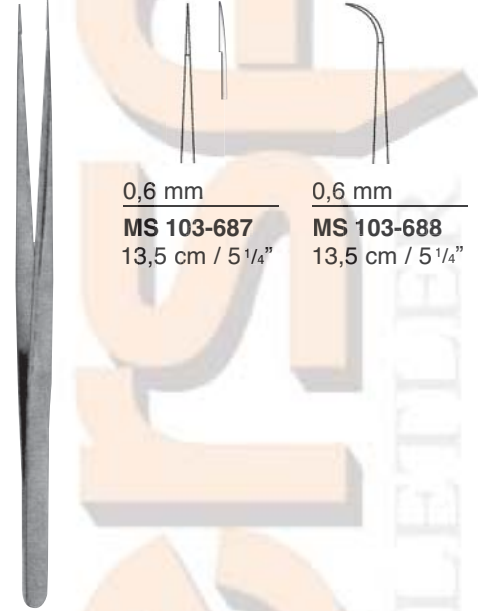

VISE

0,6 mm
MS 103-687
13,5 cm / 5 1/4"

0,6 mm
MS 103-688
13,5 cm / 5 1/4"

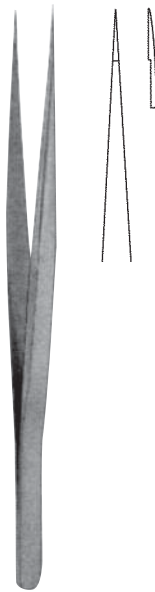

MS 103-689 12,0 cm / 4 3/4"



LAZAR

0,5 mm
MS 103-690
15,5 cm / 6 1/8"

0,8 mm
MS 103-691
15,5 cm / 6 1/8"



ADSON

- MS 103-700** 12,0 cm / 4³/₄"
- MS 103-701** 15,0 cm / 6"



MICRO-ADSON

- MS 103-702** 12,0 cm / 4³/₄"
- MS 103-703** 15,0 cm / 6"



STANDART

- MS 103-720** 14,5 cm / 5³/₄"
- MS 103-721** 16,0 cm / 6¹/₄"
- MS 103-722** 18,0 cm / 7"
- MS 103-723** 20,0 cm / 8"
- MS 103-724** 25,0 cm / 10"

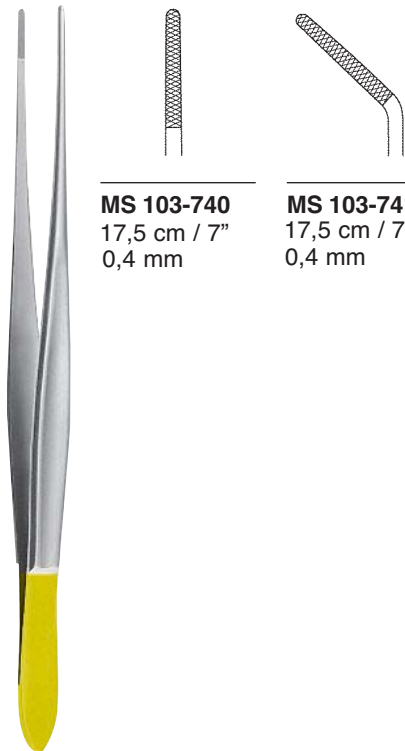

CUSHING

MS 103-740
17,5 cm / 7"
0,4 mm

MS 103-741
17,5 cm / 7"
0,4 mm



CUSHING-TAYLOR

MS 103-742 18,0 cm / 7"



0,4 mm

POTTS-SMITH

MS 103-750	15,0 cm / 6"
MS 103-751	18,0 cm / 7"
MS 103-752	20,0 cm / 8"
MS 103-753	23,0 cm / 9"
MS 103-754	25,0 cm / 10"



0,4 mm

SEMKEN

MS 103-760	15,0 cm / 6"
-------------------	--------------



0,4 mm

MC INDOE

MS 103-761	15,0 cm / 6"
-------------------	--------------



0,5 mm

WANGENSTEEN

MS 103-770	15,0 cm / 6"
MS 103-771	23,0 cm / 9"
MS 103-772	25,0 cm / 10"



0,4 mm

ADSON

MS 103-780	12,0 cm / 4 ³ / ₄ "
MS 103-781	15,0 cm / 6"



0,4 mm

MICRO-ADSON

MS 103-782	12,0 cm / 4 ³ / ₄ "
MS 103-783	15,0 cm / 6"



0,4 mm

ADSON-BROWN

MS 103-784	12,0 cm / 4 ³ / ₄ "
-------------------	---



OEHLER

- MS 103-790 14,0 cm / 5 1/2"
- MS 103-791 16,0 cm / 6 1/4"
- MS 103-792 18,0 cm / 7"
- MS 103-793 20,0 cm / 8"
- MS 103-794 25,0 cm / 10"
- MS 103-795 30,0 cm / 12"



BONNEY

- MS 103-800 18,0 cm / 7"



FERRIS-SMITH

- MS 103-801 18,0 cm / 7"



SEMKEN

- MS 103-803 15,0 cm / 6"



GILLIES

- MS 103-804 15,0 cm / 6"

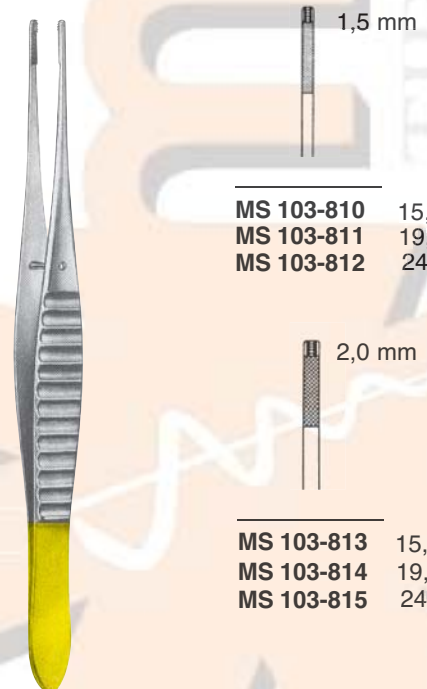

DEBAKEY

- MS 103-810 15,0 cm / 6"
- MS 103-811 19,0 cm / 7 1/2"
- MS 103-812 24,0 cm / 9 1/2"

- MS 103-813 15,0 cm / 6"
- MS 103-814 19,0 cm / 7 1/2"
- MS 103-815 24,0 cm / 9 1/2"



STIEGLITZ



MS 103-830
13,5 cm / 5 1/4"

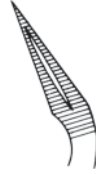

MS 103-831
13,5 cm / 5 1/4"

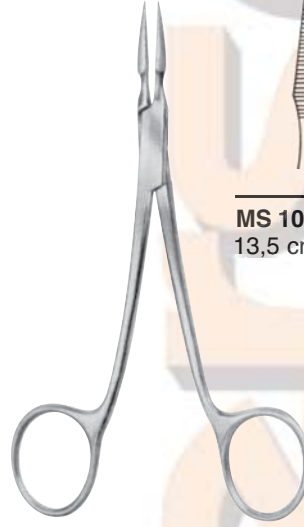

STIEGLITZ



MS 103-832
13,5 cm / 5 1/4"



MS 103-833
13,5 cm / 5 1/4"

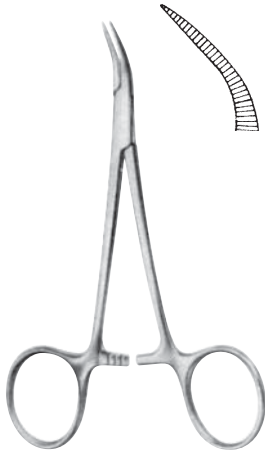

PEET

MS 103-834 11,5 cm / 4 1/2"



RALK (VIRTUS)



MS 103-835
15,0 cm / 6"

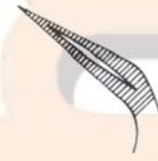

MS 103-836
15,0 cm / 6"